

ATI TOOLS

A Snap-on Specialty Tools Brand

ALATI ZA PROIZVODNJU I
ODRŽAVANJE
ZRAKOPLOVA



since 1997

RONDO

www.rondodoo.hr



www.snapon.hr

KATALOG PROIZVODA

A legacy brand serving OEM customers and airlines since 1938!

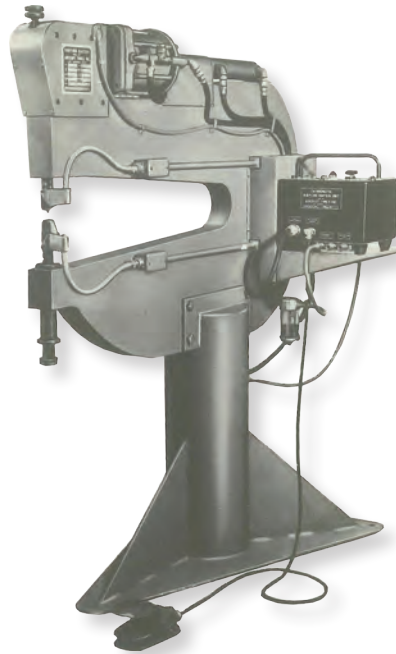
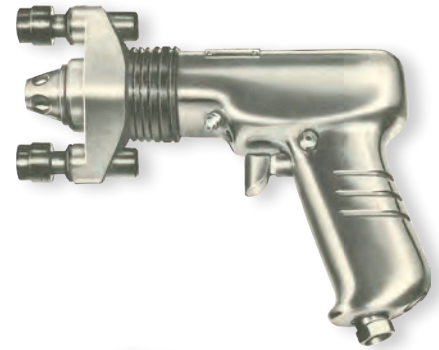
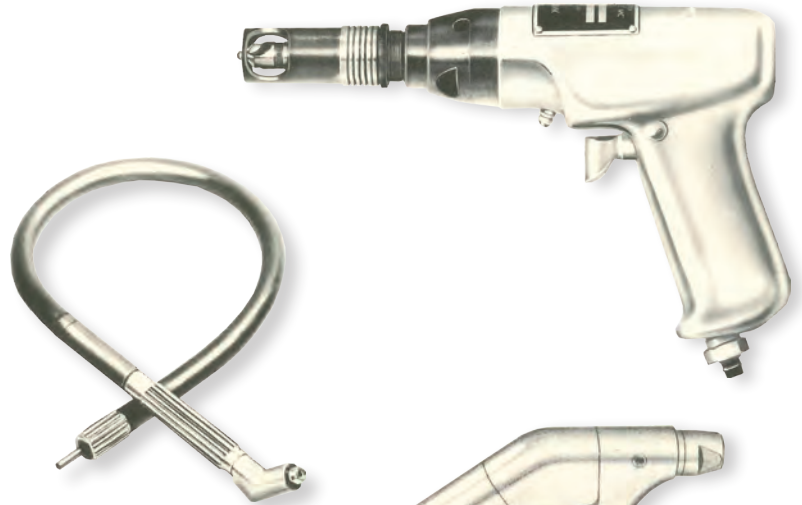
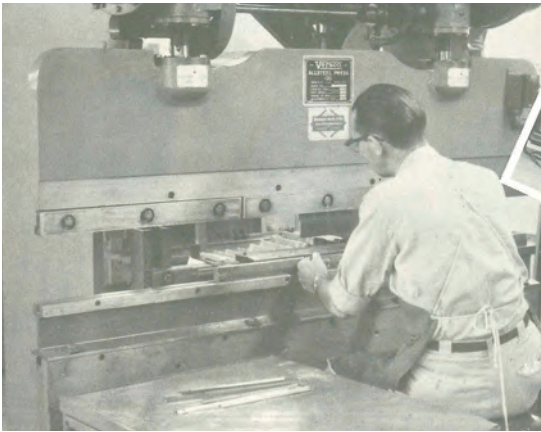
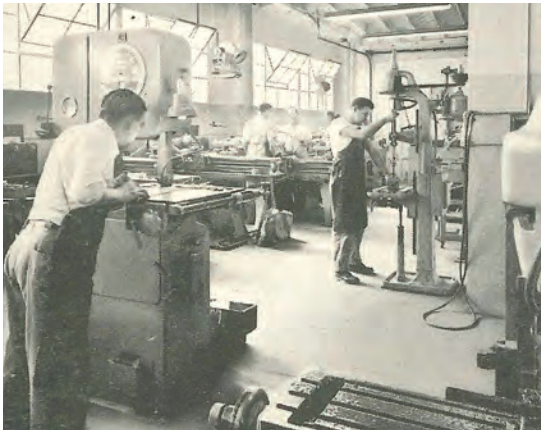

THE ATI® STORY



ATI was formed in 1938 in Los Angeles, California and incorporated as Aircraft Tools, Inc., in 1949. Strategically located near LA International Airport, we were able to serve Douglas, Northrop, Lockheed and North American Aviation. In the mid-1950s, we opened several U.S. sales offices in order to support other companies like Boeing, Grumman, Beech, Cessna, General Dynamics, LTV, Sikorsky, Rohr and Bell Helicopter. As business changed in the late 1950s, we began soliciting machine shop work and formed a tool and an aerospace division that allowed us to grow substantially.

In 1966, ATI relocated to Escondido, CA, just north of San Diego. It had established itself as the largest supplier of quality aircraft fabricating tools in the United States and Canada. In 1972, the employees of ATI purchased the company and changed the name to ATI Industries. We began concentrating on international markets, setting up sales distribution into 35 countries. In March of 1986, ATI brand was sold to, and became a subsidiary of, Snap-on Tools Incorporated.

When defense budgets were drastically reduced in the early 1990s, ATI terminated all aerospace missile component work to concentrate solely on the core commercial tools business. In keeping with this focus, we changed our company name to ATI Tools, Inc. and kept that name until January 1, 1996, when we became ATI Tools Division, Snap-on Tools Company.

In early 2009, ATI consolidated with CDI Torque, another Snap-on Tools company, and formed Snap-on Specialty Tools, which resides today in City of Industry, California. Snap-on Specialty Tools has a full service design and engineering staff and the capabilities to build custom tools for specific applications. ATI tools adhere to Snap-on's rigid engineering standards including:

Certified:

ISO 9001:2008 Certificate No.: CERT-08745-2006-AQ-HOU-ANAB Rev. 1
ISO 14001:2004 Certificate No.: CERT-02711-2006-AE-HOU-ANAB
18001:2007 Certificate No.: CERT-03904-2006-SOC-HOU-OHSAS

Adhere to:

ISO 190011 – Audit Standards
ISO 17025 (ANSI NCSL-2540-1-1994)
laboratory Calibration Standard
ANSI/NCSL Z540-1, American National Standard for Calibration
ANSI/ASQ Z1.4-2003 and MIL-STD-105E
Sampling Inspection Plan

We also adhere to many other product-specific standards:

MIL standards
ANSI standards
GOV standards
ISO standards
ASME standards
NIST standards

We trust this catalog will serve as a reference guide for your fabricating tool needs. Thanks for your continued support and business.

Snap-on Incorporated

Who We Are

OUR MISSION

The most valued productivity solutions in the world

BELIEFS

We deeply believe in:

Non-negotiable Product and Workplace Safety
 Uncompromising Quality
 Passionate Customer Care
 Fearless Innovation
 Rapid Continuous Improvement

VALUES

Our behaviors define our success:

We demonstrate Integrity.
 We tell the Truth.
 We respect the Individual.
 We promote Teamwork.
 We Listen.

VISION

To be acknowledged as the:

Brands of Choice
 Employer of Choice
 Franchisor of Choice
 Business Partner of Choice
 Investment of Choice

»» Manufacturing Excellence

Through meticulous manufacturing, precise heat treatment specifications, rigid inspection standards and skilled craftsmanship, we provide safe, functional and cost-effective aircraft tools engineered to perform, meet, and exceed the standards of serious aviation professionals.

We are dedicated to exceeding customer expectations by manufacturing and delivering the highest quality tools on time and within budget. Uncompromising attention to detail, versatility, and demand for superior quality enables us to provide customers with cutting-edge solutions to their tool needs.

»» SHIPPING:

Shipments are FOB our dock, City of Industry, CA, at which point title transfers to the Customer. All shipments are freight collect.

»» WARRANTY:

We warranty our tools against defects in material and workmanship for a period of ninety days after shipment. The warranty does not apply to any product that has been used, abused, or worn out from use. If the tool has been modified in any way, except for etching on the tool, the warranty is null and void.

»» RETURN POLICY:

- All returns require approval and an RMA number. Under no circumstances shall arbitrary returns or debits be accepted and/or approved. Returns received by ATI without an authorized RMA number will be returned to the customer, freight collect.
- Shipments must be clearly identified on the outside with the authorized RMA number.
- All items considered for return must be in new and resalable condition.
- Returns may be subject to a restocking charge and/or an offsetting order equal to one and one-half (1.5) times the net value of items being returned. The only exception to this rule is when ATI has shipped items in error.
- All items considered for return must have been purchased within 60 days.
- All returns must be shipped freight pre-paid to City of Industry, CA. Credit for shipping will be issued only on return of goods originally shipped in error by ATI.



TABLE OF CONTENTS

RIVETING TOOLS AND ACCESSORIES 4

- Rivet Sets, Straight and Offset..... 6-7
- Jiffy Rivet Sets 8
- Flush Rivet Sets 9-10
- Huck® and Hi-Shear® Rivet Sets 11
- Gun Type Chisels..... 12
- Knock-Out Punches 12
- 90° Riveting Attachments 13
- Rivet Hammers 14
- Rivet Set Extensions..... 15
- Grip Gauges..... 15
- Sheet-Metal Tool Kits 16
- Rivet Cutters 16
- Rivet Squeezer Sets and Kits 17
- Hand Rivet Squeezers 18
- Pneumatic Rivet Squeezers 18

BUCKING BARS 19

- Tungsten 20-21
- Standard 22-30
- Recoilless Bucking Bar Kit 31

DIMPLE DIES AND DIMPLING EQUIPMENT 32

- Cold Dimple Dies 33
- Dimpling Equipment and Hot Dimple Dies..... 34-35

DRILL ATTACHMENTS AND DRILLING ACCESSORIES .. 36

- Direct and Flex Drive; 45°, 90°, and 360°..... 37
- Offset Drill Attachments 37
- Drill Guide Housings and Bushings..... 38-39
- Strap Duplicators..... 40
- Drill Adaptors, Drill Collets and Drill Stops 41
- Threaded Shank Drills..... 42
- Speed Drivers, Deburring Cutters and Blades 42
- Chip Chasers..... 42
- Edge Breakers and Burnishing Tool..... 43
- Duplicating Punches..... 43
- Drill Jigs 44-49

CUTTING TOOLS AND MICROSTOPS 50

- Countersink Cutters, Integral Pilot, Threaded Shank.... 52-53
- Replaceable Pilot Countersinks, Threaded Shank..... 54
- Metric Countersink Cutters 55
- Countersink Pilots..... 56
- Briles® Countersink Cutters..... 56
- Countersink Extensions..... 56
- Microstops, Standard..... 57-58
- Quick-Change Chucks 59
- Microstops, Jumbo..... 59
- Back Countersinks and Spotfacers, Gunlock Pilots 60-61
- Countersink Cutters, Straight Shank 61-62
- Chatterless Countersink Cutters..... 62
- Hollow Cutters 62
- Hole Saws and Arbors..... 63-64
- Counterbores and Pilots 65
- Counterbore Extensions 65
- Rivet Shaver and Shaver Bits 66

HI-LOK® TOOLS AND ACCESSORIES 67

- Hi-Lok® Ratchets, Sockets, and Extensions 68
- Hi-Lok® Installation Kits 68
- Hi-Lok® Roller Clutch Wrenches..... 69-70
- Hi-Lok® Removal Pliers 70
- Frangible Collar Removal Sockets 70

SHOP TOOLS..... 71

- Cannon Plug Connector Pliers 72
- Sheet-Holder and Camloc Pliers..... 72
- Spring Tension and Side-Grip Clamps..... 73
- Temporary Fasteners..... 73-74
- Skin Clamp Runner 74
- Screwdriver Bits 75
- Screw Removal Tools 75-76
- Mina-Vacs..... 76
- Ratcheting Tube Wrenches..... 77
- Valve Core Removal Tool 78
- Digital Protractor..... 78
- Tensiometers 78

SWAGING EQUIPMENT..... 79

- Stationary Swager 80
- Portable Swager 81
- Swaging Dies 81
- Pull Tester Kits..... 82
- Calibration Kit 82
- Hydraulic Swager..... 83

RIVETING TOOLS AND ACCESSORIES

RIVET SET CUPPING STANDARD FOR AN & MS RIVETS



Rivet set cups are machined to a larger radius than the maximum rivet head radius and are shallower in cup depth than the minimum thickness:



- (1) To allow for a slight upsetting of the head in forming the upset end.
- (2) To allow for a slight misalignment in holding the set on the rivet head without touching the riveted surface.

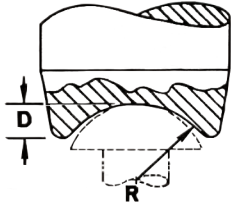

AN 430 AN 456
AN 435 MS 20435

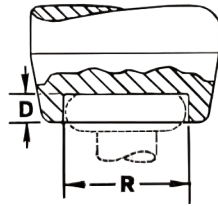

AN 442

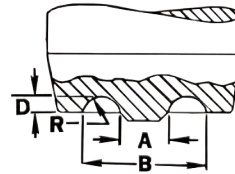

AN 450 MS 20450

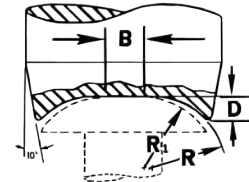

AN 470 MS 20470

Rivet Number	Rivet Type	DIM	RIVET SIZE							
			1/16"	3/32"	1/8"	5/32"	3/16"	1/4"	5/16"	3/8"
AN430	ROUND HEAD	R	.075	.112	.161	.184	.222	.298	.369	.445
		D	.031	.049	.068	.086	.104	.139	.162	.195
AN435 MS20435	BUTTON HEAD	R	.061	.095	.128	.160	.192	.256	.321	.382
		D	.040	.063	.084	.105	.126	.168	.206	.243
AN442	FLAT HEAD	R	.141	.204	.267	.333	.399	.530	.661	.792
		D	.014	.022	.032	.042	.052	.072	.092	.110
AN456	MODIFIED BRAZIER HEAD	R	-	.142	.213	.284	.354	.415	.567	.709
		D	-	.018	.030	.047	.057	.069	.094	.116
AN470 MS20470 MS20613 MS20615	UNIVERSAL HEAD	B	.041	.056	.072	.088	.103	.135	.166	.200
		D	.019	.027	.040	.049	.057	.077	.100	.122
		R	.070	.098	.124	.152	.180	.233	.288	.345
		R ₁	.054	.082	.108	.135	.164	.217	.272	.328
AN450 MS20450	THOMPSON HEAD (TUBULAR)		1/16"	3/32"	#40	1/8"	9/64"	3/16"	1/4"	
		A	.033	.055	.069	.082	.094	.130	.170	
		B	.110	.158	.160	.205	.258	.294	.366	
		R	.019	.026	.023	.031	.041	.041	.049	
	D	.014	.021	.023	.031	.041	.041	.045		

COMPARE THE DIFFERENCE



Protected with plastic coating to prevent damage during shipment and storage

1/32" Blend radius between cup and chamfer
Cup configurations are in accordance with applicable rivet specifications

Part number stamped designating rivet size and type

Flush sets have a slight crown on the face

Precision machined and polished

Chromium Vanadium Alloy Steel









Chamfered corners

Available from stock in overall lengths of 2-1/2", 3-1/2", 5-1/2", 7-1/2" and 10-1/2", for rivet sizes 3/32", 1/8", 5/32", 3/16" and 1/4"

CAUTION: Power tools can cause flying particles.
WEAR SAFETY GOGGLES (users and bystanders).
WEAR HEARING PROTECTION. Power tools generate noise.

Beginning with a sound basic design, ATI rivet sets incorporate the ultimate in proper distribution of mass, with correct grain structure, made possible by the cold heading process. These factors along with correct heat-treating procedures eliminate breakage and provide for a structurally sound driven rivet.

Highly polished precision cups are held to exact tolerances, and shanks are CNC- machined and chamfered. Identifying symbols stamped on all sets show rivet size, type and tool number. The working surface of each unit is coated with clear plastic to prevent damage during shipment.

RIVET TYPE CHART								
								
AN435 Button	AN430 Round	AN455 Brazier	AN456 Mod. Brazier	AN470 Universal	AN442 Flat	BACR 15FT Boeing Reduced Head	AN426 Countersunk	AN450 Semi-Tubular

RIVETING TOOLS AND ACCESSORIES

STRAIGHT AND OFFSET RIVET SETS

*Special rivet sets may be ordered by providing rivet size, type, length, and shank diameter.

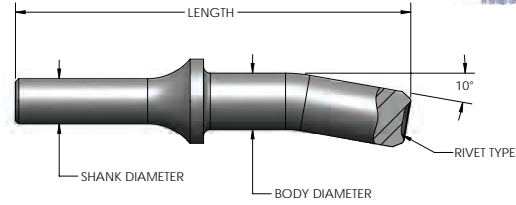
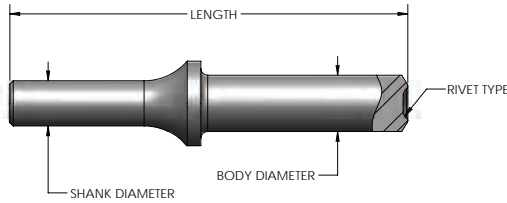

Rivet Size	Length	AN470 RIVET, .401 SHANK		
		Straight Drive Part Number	Offset Drive Part Number	Body Diameter
1/16"	3-1/2"	ATI100A31/16	ATI101A31/16	1/2"
3/32"	2-1/2"	ATI100A2-332	-	1/2"
	3-1/2"	ATI100A33/32	ATI101A33/32	1/2"
	5-1/2"	ATI100A53/32	ATI101A53/32	1/2"
	7-1/2"	ATI100A73/32	ATI101A73/32	1/2"
	10-1/2"	ATI100A8332	ATI101A8332	1/2"
	13-1/2"	ATI100A93/32	-	1/2"
1/8"	2-1/2"	ATI100A218	-	1/2"
	3-1/2"	ATI100A3-1/8	ATI101A3-1/8	1/2"
	5-1/2"	ATI100A51/8	ATI101A51/8	1/2"
	7-1/2"	ATI100A71/8	ATI101A71/8	1/2"
	10-1/2"	ATI100A818	ATI101A818	1/2"
	13-1/2"	ATI100A91/8	ATI101A91/8	1/2"
5/32"	2-1/2"	ATI100A2532	-	1/2"
	3-1/2"	ATI100A35/32	ATI101A35/32	1/2"
	5-1/2"	ATI100A55/32	ATI101A5-532	1/2"
	7-1/2"	ATI100A75/32	ATI101A75/32	1/2"
	10-1/2"	ATI100A8532	ATI101A8532	1/2"
	13-1/2"	ATI100A95/32	ATI101A95/32	1/2"
3/16"	2-1/2"	ATI100A2316	-	1/2"
	3-1/2"	ATI100A33/16	ATI101A3316	1/2"
	5-1/2"	ATI100A53/16	ATI101A53/16	1/2"
	7-1/2"	ATI100A73/16	ATI101A73/16	1/2"
	10-1/2"	ATI100A8316	ATI101A8316	1/2"
	13-1/2"	ATI100A93/16	ATI101A93/16	1/2"
7/32"	2-1/2"	ATI100A2732	-	1/2"
	3-1/2"	ATI100A37/32	ATI101A3732	1/2"
	5-1/2"	ATI100A57/32	ATI101A57/32	1/2"
	7-1/2"	ATI100A77/32	ATI101A77/32	1/2"
	10-1/2"	ATI100A8732	-	1/2"
1/4"	2-1/2"	ATI100A214	-	5/8"
	3-1/2"	ATI100A3-1/4	ATI101A3-1/4	5/8"
	5-1/2"	ATI100A514	ATI101A514	5/8"
	7-1/2"	ATI100A7-1/4	ATI101A7-1/4	5/8"
	10-1/2"	ATI100A814	-	5/8"
	13-1/2"	ATI100A9-1/4	ATI101A9-1/4	5/8"
FLUSH	2-1/2"	ATI100AF-2A	ATI101AF-2A	1/2"
	2-1/2"	ATI100AF-2B	ATI101AF-2B	5/8"
	3-1/2"	ATI100AF-3A	ATI101AF-3A	1/2"
	3-1/2"	ATI100AF-3B	ATI101AF-3B	5/8"
	5-1/2"	ATI100AF-5A	ATI101AF-5A	1/2"
	5-1/2"	ATI100AF-5B	ATI101AF-5B	5/8"
	7-1/2"	ATI100AF-7A	ATI101AF-7A	1/2"
	10-1/2"	ATI100AF8A	ATI101AF8A	1/2"
	13-1/2"	ATI100AF-9A	ATI101AF-9A	1/2"

Rivet Size	Length	AN470 RIVET, .498 SHANK	
		Straight Drive Part Number	Body Diameter
5/32"	3-1/2"	ATI100B35/32	5/8"
	5-1/2"	ATI100B55/32	5/8"
	7-1/2"	ATI100B75/32	5/8"
	10-1/2"	ATI100B8532	5/8"
	13-1/2"	ATI100B95/32	5/8"
3/16"	3-1/2"	ATI100B33/16	5/8"
	5-1/2"	ATI100B53/16	5/8"
	7-1/2"	ATI100B73/16	5/8"
	10-1/2"	ATI100B8316	5/8"
7/32"	3-1/2"	ATI100B37/32	5/8"
	5-1/2"	ATI100B57/32	5/8"
	7-1/2"	ATI100B77/32	5/8"
	10-1/2"	ATI100B8732	5/8"
1/4"	3-1/2"	ATI100B3-1/4	5/8"
	5-1/2"	ATI100B514	5/8"
	7-1/2"	ATI100B7-1/4	5/8"
	10-1/2"	ATI100B814	5/8"
	13-1/2"	ATI100B9-1/4	5/8"
FLUSH	3-1/2"	ATI100BF-3B	5/8"
	5-1/2"	ATI100BF-5B	5/8"
	7-1/2"	ATI100BF-7B	5/8"

Rivet Size	Length	AN470 RIVET, .498 SHANK	
		Offset Drive Part Number	Body Diameter
1/4"	3-1/2"	ATI101B3-1/4	5/8"
	5-1/2"	ATI101B514	5/8"

Rivet Size	Length	AN430 RIVET, .401 SHANK		AN435 RIVET, .401 SHANK		AN455 RIVET, .401 SHANK	
		Part Number	Body Dia.	Part Number	Body Dia.	Part Number	Body Dia.
3/32"	3-1/2"	ATI100A3332A	1/2"	ATI100A3332B	1/2"	ATI100A3332E	1/2"
1/8"		ATI100A31/8A	1/2"	ATI100A31/8B	1/2"	ATI100A31/8E	1/2"
5/32"		ATI100A3532A	1/2"	ATI100A3532B	1/2"	ATI100A3532E	1/2"
3/16"		ATI100A3316A	1/2"	ATI100A3316B	1/2"	ATI100A3316E	1/2"
1/4"		ATI100A31/4A	5/8"	ATI100A31/4B	5/8"		
		ATI100A71/4A	5/8"				



SAFETY PRECAUTION: Read and follow all safety and operating instructions.

WARNING: Face & eye protection must be worn while operating power tools, per ANSI B186.1

STRAIGHT AND OFFSET RIVET SETS

*Special rivet sets may be ordered by providing rivet size, type, length, and shank diameter.

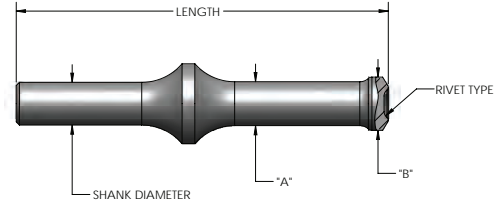
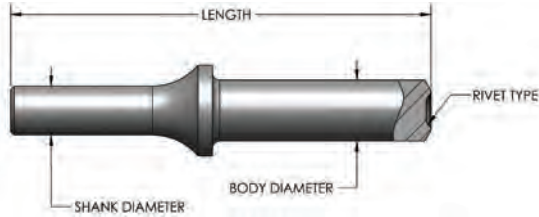

STRAIGHT RIVET SETS FOR MODIFIED UNIVERSAL HEAD RIVETS, .401 SHANK

Rivet Size	Length	BACR15FT RIVET	
		Part Number	Body Diameter
3/32"	3-1/2"	ATI100A3332F	1/2"
	5-1/2"	ATI100A5332F	1/2"
1/8"	2-1/2"	ATI100A21/8F	1/2"
	3-1/2"	ATI100A31/8F	1/2"
	5-1/2"	ATI100A51/8F	1/2"
5/32"	2-1/2"	ATI100A2532F	1/2"
	3-1/2"	ATI100A3532F	1/2"
	5-1/2"	ATI100A5532F	1/2"
3/16"	2-1/2"	ATI100A2316F	1/2"
	3-1/2"	ATI100A3316F	1/2"
	5-1/2"	ATI100A5316F	1/2"
	7-1/2"	ATI100A7316F	1/2"
7/32"	2-1/2"	ATI100A2732F	1/2"
	3-1/2"	ATI100A3732F	1/2"
	5-1/2"	ATI100A5732F	1/2"
1/4"	2-1/2"	ATI100A21/4F	5/8"
	3-1/2"	ATI100A31/4F	5/8"
	5-1/2"	ATI100A51/4F	5/8"

STRAIGHT RIVET SETS FOR MODIFIED UNIVERSAL HEAD RIVETS, .401 SHANK

Manufactured from H13 material and magnetic particle tested

Rivet Size	Part Number	BACR15FT RIVET			
		Reference	Dimension "A"	Dimension "B"	Length
1/8"	1112MBC4014	ST1112MB-C401-4	.280	.280	3.31"
	ST1112BC453	ST1112B-C401-4-53	.281	.437	3.31"
5/32"	1112MBC4015	ST1112MB-C401-5	.310	.350	3.31"
	1112MBC401A5	ST1112MB-C401A-5	.310	.310	3.31"
	ST1112BC553	ST1112B-C401-5-53	.312	.500	3.31"
3/16"	1112MBC4016	ST1112MB-C401-6	.340	.410	3.31"
	1112MBC401A6	ST1112MB-C401A-6	.340	.368	3.31"
	ST1112BC653	ST1112B-C401-6-53	.344	.562	3.31"
	1112BC401637	ST1112B-C401-6-37	.562	.562	2.31"
7/32"	ST1112MBC7	ST1112MB-C401-7	.380	.480	3.31"
	1112MBC401A7	ST1112MB-C401A-7	.380	.406	3.31"
1/4"	1112MBC4018	ST1112MB-C401-8	.410	.540	3.31"
	1112MBC401A8	ST1112MB-C401A-8	.410	.482	3.31"
	ST1112BC853	ST1112B-C401-8-53	.406	.656	3.31"
	1112BC401837	ST1112B-C401-8-37	.656	.656	2.31"
9/32"	1112MBC4019	ST1112MB-C401-9	.440	.610	3.31"

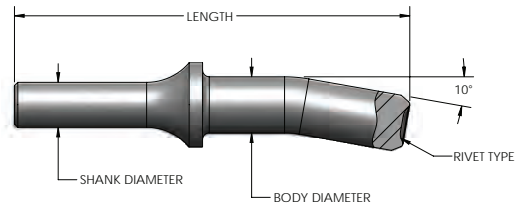
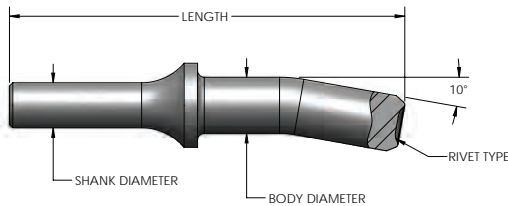

OFFSET RIVET SETS FOR MODIFIED UNIVERSAL HEAD RIVETS, .401 SHANK

Rivet Size	Length	BACR15FT RIVET	
		Part Number	Body Diameter
1/8"	3-1/2"	ATI101A31/8F	1/2"
	5-1/2"	ATI101A518F	1/2"
5/32"	3-1/2"	ATI101A3532F	1/2"
	5-1/2"	ATI101A5532F	1/2"
3/16"	3-1/2"	ATI101A3316F	1/2"
	5-1/2"	ATI101A5316F	1/2"
7/32"	3-1/2"	ATI101A3732F	1/2"
	5-1/2"	ATI101A5732F	1/2"
1/4"	3-1/2"	ATI101A31/4F	5/8"
	5-1/2"	ATI101A514F	5/8"

OFFSET RIVET SETS FOR MODIFIED UNIVERSAL HEAD RIVETS, .401 SHANK

Manufactured from H13 material and magnetic particle tested

Rivet Size	Length	Part Number	BACR15FT RIVET	
			Reference	Body Diameter
1/8"	3-1/2"	1112MBR40143	ST1112MB-R401-4-3	.375
5/32"	3-1/2"	1112MBR40153	ST1112MB-R401-5-3	.410
	5-1/2"	1112MBR40155	ST1112MB-R401-5-5	.410
3/16"	3-1/2"	ST1112MBR63	ST1112MB-R401-6-3	.480
	5-1/2"	*ST1112MBR611	ST1112MB-R401C-611	.560
7/32"	3-1/2"	1112MBR40173	ST1112MB-R401-7-3	.560
	5-1/2"	1112MBR40175	ST1112MB-R401-7-5	.560
1/4"	3-1/2"	1112MBR40183	ST1112MB-R401-8-3	.610

*ST1112MBR611 has 20° offset



SAFETY PRECAUTION: Read and follow all safety and operating instructions.
WARNING: Face & eye protection must be worn while operating power tools, per ANSI B186.1

RIVETING TOOLS AND ACCESSORIES

JIFFY TYPE RIVET SETS , GOOSENECKS, AND DOUBLE OFFSETS

*Special Jiffy sets may be ordered by providing rivet size, type, length, and shank diameter.

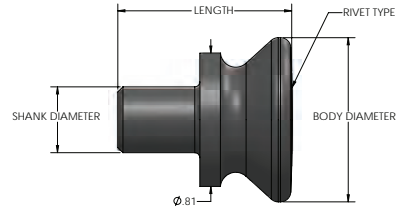
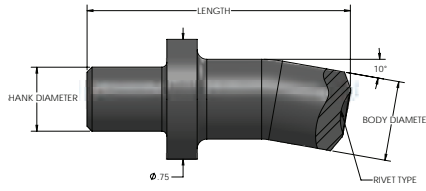
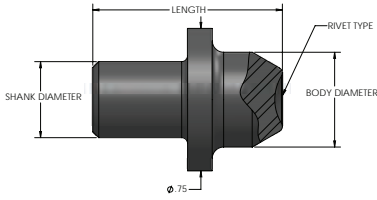

STRAIGHT JIFFY SETS

Part Number	Rivet Size	Rivet Type	Length	Body Diameter	Shank Diameter
JAT100AF-1A	FLUSH	FLUSH	1"	1/2"	.401
JAT119A-2B	FLUSH	FLUSH	2-1/8"	1" FACE	.401
JAT100A1332	3/32"	AN470	1"	1/2"	.401
JAT100A118	1/8"	AN470	1"	1/2"	.401
JAT100A1532	5/32"	AN470	1"	1/2"	.401
JAT100A1316	3/16"	AN470	1"	1/2"	.401

OFFSET JIFFY SETS

Part Number	Rivet Size	Rivet Type	Length	Body Diameter	Shank Diameter
JAT101A1332	3/32"	AN470	1-5/8"	1/2"	.401
JAT101A118	1/8"	AN470	1-5/8"	1/2"	.401
JAT101A1532	5/32"	AN470	1-5/8"	1/2"	.401
JAT101A1316	3/16"	AN470	1-5/8"	1/2"	.401

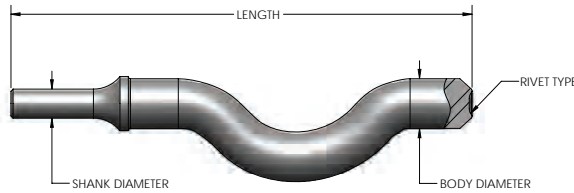

GOOSENECK RIVET SETS

Part Number	Rivet Size	Rivet Type	Length	Body Diameter	Shank Diameter
ATI104AF	FLUSH	FLUSH	6-5/8"	.69	.401
ATI104A-1/16	1/16"	AN470	6-5/8"	.69	.401
ATI104A-3/32	3/32"	AN470	6-5/8"	.69	.401
ATI104A-1/8	1/8"	AN470	6-5/8"	.69	.401
ATI104A-5/32	5/32"	AN470	6-5/8"	.69	.401
ATI104A-3/16	3/16"	AN470	6-5/8"	.69	.401
ATI104A-7/32	7/32"	AN470	6-5/8"	.69	.401
ATI104A-1/4	1/4"	AN470	6-5/8"	.69	.401

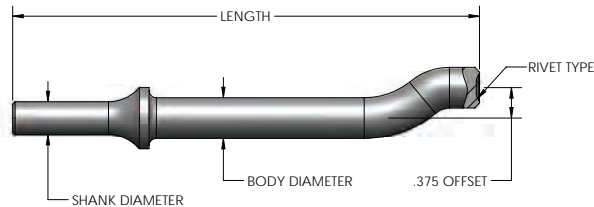

DOUBLE OFFSET RIVET SETS

Part Number	Rivet Size	Rivet Type	Length	Body Diameter	Shank Diameter
ATI105AF	FLUSH	FLUSH	5-3/4"	1/2"	.401
ATI105A-1/16	1/16"	AN470	5-3/4"	1/2"	.401
ATI105A-3/32	3/32"	AN470	5-3/4"	1/2"	.401
ATI105A-1/8	1/8"	AN470	5-3/4"	1/2"	.401
ATI105A-5/32	5/32"	AN470	5-3/4"	1/2"	.401
ATI105A-3/16	3/16"	AN470	5-3/4"	1/2"	.401
ATI105A-7/32	7/32"	AN470	5-3/4"	1/2"	.401
ATI105A-1/4	1/4"	AN470	5-3/4"	1/2"	.401
ATI105A-9/32	9/32"	AN470	5-3/4"	1/2"	.401





ATI106A

FLUSH RIVET SET, SWIVEL-TYPE

Performs high-speed flush riveting on flat or curved surfaces and is designed for ease of handling, with a swivel action to produce quick alignment. The highly polished rivet set head is enclosed in a rubber sleeve.

Part Number	Face Diameter	Length	Shank Diameter
ATI106A	1-1/4"	3-1/2"	.401
ATI106B	1-1/4"	3-1/2"	.498

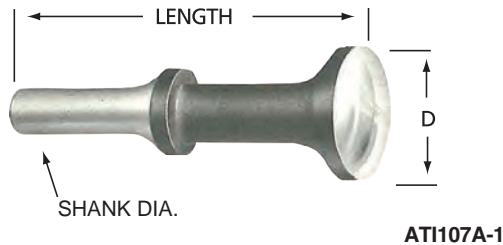

ATI107A-1

FLUSH RIVET SET

Large radii at critical points enable this rivet set to withstand continuous rugged use. Where a smooth skin surface is essential, this rivet set, with its slightly crowned and highly polished face, will perform rapid flush riveting.

Part Number	Face Diameter	Length	Shank Diameter
ATI107A-1	1"	2-3/4"	.401
ATI107A-2	1-1/4"	2-3/4"	.401
ATI107A-3	1-1/4"	3-1/2"	.401
ATI107A-4	1"	5-1/2"	.401
ATI107A-6	1"	7-1/2"	.401
ATI107A-7	1-1/4"	7-1/2"	.401
ATI107B-1	1"	3"	.498
ATI107B-2	1-1/4"	3"	.498
ATI107B3	1-1/4"	3-1/2"	.498
ATI107B-4	1"	5-1/2"	.498
ATI107B-5	1-1/4"	5-1/2"	.498
ATI107B-6	1"	7-1/2"	.498
ATI107B-7	1-1/4"	7-1/2"	.498

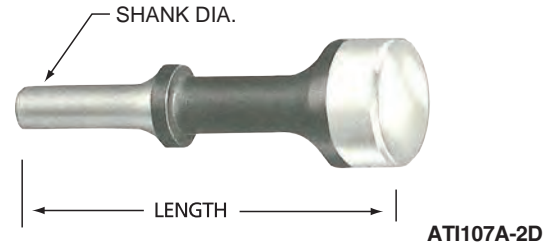

ATI107A-2D

PEENING TOOL WITH ALUMINUM, BRASS, OR NYLON INSERT

This peening tool is designed for the straightening of aluminum sheet after forming.

Part Number	Head Material	Face Diameter	Length	Shank Diameter
ATI107A-2D	Aluminum	1"	3-1/8"	.401
ATI107A2DB	Brass	1"	3-1/8"	.401
ATI107A2DN	Nylon	1"	3-1/8"	.401
ATI107B-2D	Aluminum	1"	3-1/8"	.498

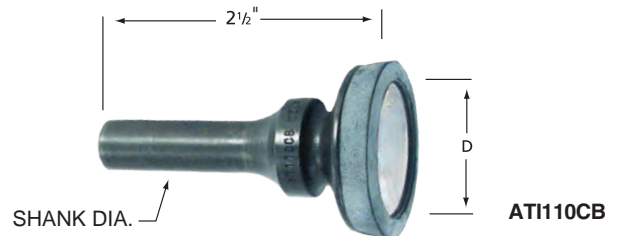

ATI110CB

FLUSH RIVET SET WITH RUBBER GUARD

A rubber guard added to this flush rivet set helps prevent slippage and damage to skin surface.

Part Number	Face Diameter	Length	Shank Diameter
ATI110CA	3/4"	2-1/2"	.401
ATI110CB	1"	2-1/2"	.401
ATI110CC	1-1/4"	2-1/2"	.401



ATI112A

FLUSH RIVET SET, MUSHROOM TYPE

This convex crowned, flush rivet set is particularly adapted to riveting thin sections without danger of denting or dishing skin surface.

Part Number	Face Diameter	Length	Shank Diameter
ATI112A	1-7/8"	3"	.401
ATI112B	1-7/8"	3"	.498



SAFETY PRECAUTION: Read and follow all safety and operating instructions.
WARNING: Face & eye protection must be worn while operating power tools, per ANSI B186.1

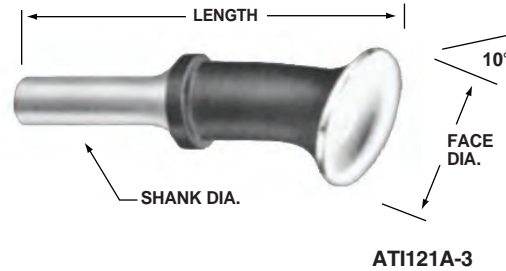
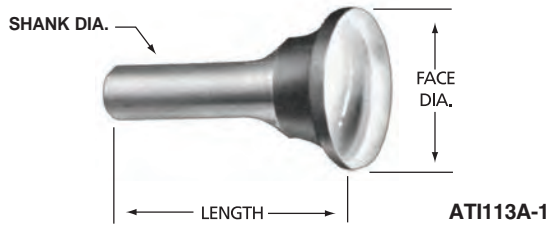

FLUSH RIVET SET, EXTRA SHORT

The unique design of this extra-short flush set enables it to withstand extremely rugged use. A mirror-polished, crown-working surface prevents damage to the skin.

Part Number	Face Diameter	Length	Shank Diameter
AT1113A-1	3/4"	1-11/16"	.401
AT1113A-2	1"	1-13/16"	.401
AT1113A-3	1-1/4"	1-13/16"	.401
*AT1113A2SPCR	1"	1-13/16"	.401

*Increased crown height

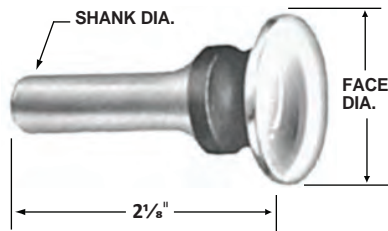

FLUSH RIVET SET, STUBBY TYPE

Part Number	Face Diameter	Length	Shank Diameter
AT1119A-1B	3/4"	2-1/8"	.401
AT1119A-2B	1"	2-1/8"	.401
AT1119A-3B	1-1/8"	2-1/8"	.401
AT1119A-4B	1-1/4"	2-1/8"	.401
AT1119B-1B	3/4"	2-1/8"	.498
AT1119B-2B	1"	2-1/8"	.498
AT1119B-3B	1-1/8"	2-1/8"	.498
AT1119B-4B	1-1/4"	2-1/8"	.498

FLUSH SET FOR LIMITED ACCESS
ST1111BP401K

Heat-treated and polished to a mirror finish. The perfect tool for those hard-to-reach riveting applications.

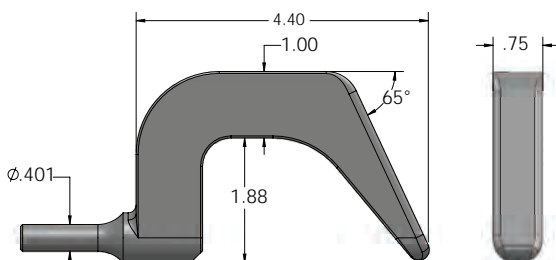

FLUSH RIVET SET, OFFSET

Part Number	Face Diameter	Length	Shank Diameter
AT1121A-3	1-1/4"	3-1/2"	.401
AT1121A-4	1"	5-1/2"	.401
AT1121A-5	1-1/4"	5-1/2"	.401
AT1121A-6	1"	7-1/2"	.401
AT1121A-7	1-1/4"	7-1/2"	.401
AT1121B-3	1-1/4"	3-1/2"	.498
AT1121B-4	1"	5-1/2"	.498
AT1121B-5	1-1/4"	5-1/2"	.498
AT1121B-6	1"	7-1/2"	.498
AT1121B-7	1-1/4"	7-1/2"	.498

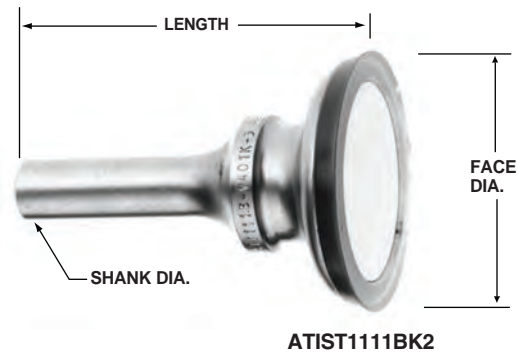

FLUSH RIVET SET, POLYURETHANE RIM

Manufactured from H-13 material tool steel, this flush set is magnetic particle tested after heat treat, and shot-peened for stress relief prior to polish. The machine crown and polyurethane rim make this a preferred set ideal for skin work.

Part Number	Reference Part Number	Replacement Rim Part Number	Face Diameter	Length	Shank Diameter
ATIST-1111BK1	ST1111B-V401K-1	ST1111BVR1	3/4"	2-1/2"	.401
ATIST-1111BK2	ST1111B-V401K-2	ST1111BVR2	1"	2-1/2"	.401
ATIST-1111BK3	ST1111B-V401K-3	ST1111BVR3	1-1/4"	2-1/2"	.401
ST-1111BV48E1	ST1111B-V498E-1	ST1111BVR1	3/4"	2-1/2"	.498
ST-1111BV48E2	ST1111B-V498E-2	ST1111BVR2	1"	2-1/2"	.498
ST-1111BV48E3	ST1111B-V498E-3	ST1111BVR3	1-1/4"	2-1/2"	.498





STRAIGHT DRIVE SETS FOR HUCK® LOCKBOLTS

Developed to drive Huck® lockbolt collars. The ATI118M Series tools are precision machined with close tolerance cavities.

Part Number	Lockbolt Size	Length	Shank Diameter
ATI118M3-L5	5/32"	3-1/2"	.401
ATI118M3-L6	3/16"	3-1/2"	.401
ATI118M3L8	1/4"	3-1/2"	.498
ATI118M-5-L5	5/32"	5-1/2"	.401

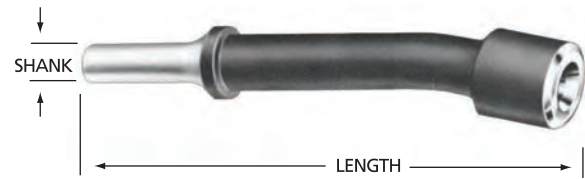

OFFSET DRIVE SETS FOR HUCK® LOCKBOLTS

Developed to drive Huck® lockbolt collars. The ATI118D Series tools are precision machined with close tolerance cavities and 10° offset.

Part Number	Lockbolt Size	Length	Shank Diameter
ATI118D3-L4	1/8"	3-1/2"	.401
ATI118D3-L5	5/32"	3-1/2"	.401
ATI118D3-L6	3/16"	3-1/2"	.498
ATI118D3L8	1/4"	3-1/2"	.401

SQUEEZER SET FOR HUCK® LOCKBOLTS

Held to an extremely close tolerance, with a mirror polished cavity, this squeezer set is ideal for fast, accurate swaging of Huck® lockbolt collars.

Part Number	Lockbolt Size	Length	"D"	Shank Diameter
ATI118AL5	5/32"	1/2"	1/2"	.187
ATI118AL6	3/16"	5/8"	9/16"	.187
ATI118AL8	1/4"	1"	5/8"	.187

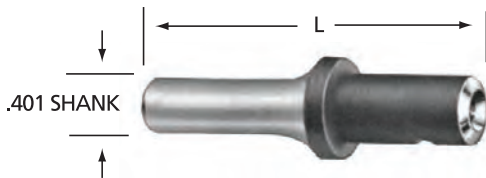
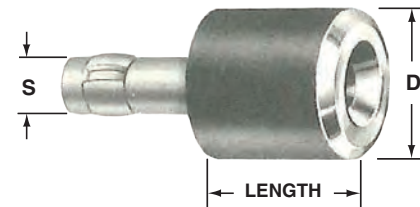

STRAIGHT DRIVE SETS FOR HI-SHEAR® RIVETS, .401 SHANK

Engineered to drive Hi-Shear® rivet collars in open areas.

Rivet Size	Length	Part Number	Body Diameter
1/8"	3-1/2"	ATI130A318	1/2"
	5-1/2"	ATI130A51/8	1/2"
	7-1/2"	ATI130A71/8	1/2"
5/32"	3-1/2"	ATI130A3532	1/2"
	5-1/2"	ATI130A55/32	1/2"
	7-1/2"	ATI130A75/32	1/2"
3/16"	3-1/2"	ATI130A3316	1/2"
	5-1/2"	ATI130A53/16	1/2"
	7-1/2"	ATI130A73/16	1/2"
1/4"	3-1/2"	ATI130A3-1/4	5/8"
	5-1/2"	ATI130A51/4	5/8"

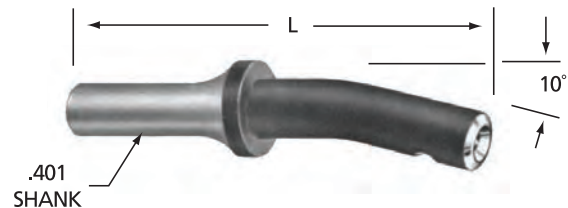

OFFSET DRIVE SETS FOR HI-SHEAR® RIVETS, .401 SHANK

Engineered to drive Hi-Shear® rivet collars in open areas and when offset riveting is required.

Rivet Size	Length	Part Number	Body Diameter
1/8"	3-1/2"	ATI131A318	1/2"
	5-1/2"	ATI131A518	1/2"
5/32"	3-1/2"	ATI131A3532	1/2"
	5-1/2"	ATI131A5532	1/2"
3/16"	3-1/2"	ATI131A3316	1/2"
	5-1/2"	ATI131A5316	1/2"
1/4"	3-1/2"	ATI131A314	5/8"
	5-1/2"	ATI131A514	5/8"



SAFETY PRECAUTION: Read and follow all safety and operating instructions.
WARNING: Face & eye protection must be worn while operating power tools, per ANSI B186.1



ATI1206-6

FLAT CHISEL, GUN TYPE

Part Number	Length	Shank Diameter
ATI1206-6	6-3/4"	.401
ATI1206-8	8"	.401
ATI1206-10	10"	.401
ATI1206-12	12"	.401



ATI2165-2

GUN TYPE CHISEL FOR HUCK® LOCKBOLTS

Part Number	Lockbolt Size	Length	Shank Diameter
ATI2165-2	5/32"	5-1/2"	.401
ATI2165-3	3/16"	5-1/2"	.401
ATI2165-4	1/4"	5-1/2"	.401
ATI2165-5	5/16"	5-1/2"	.401
ATI2165-6	3/8"	5-1/2"	.401



Hi-Shear® Knockout Punch

KNOCK-OUT PUNCH, HI-SHEAR®

Part Number	Rivet Size	Length	Shank Diameter
ATI140A-3	3/32"	3-1/2"	.401
ATI140A341/4	3/32"	4-1/4"	.401
ATI140A-3MM	3MM	3-1/2"	.401
ATI140A-4	1/8"	3-1/2"	.401
ATI140A441/4	1/8"	4-1/4"	.401
ATI140A-5	5/32"	3-1/2"	.401
ATI140A541/4	5/32"	4-1/4"	.401
ATI140A-6	3/16"	3-1/2"	.401
ATI140A641/4	3/16"	4-1/4"	.401
ATI140A-5MM	5MM	3-1/2"	.401
ATI140A-6MM	6MM	3-1/2"	.401
ATI140A-8	1/4"	3-1/2"	.401
ATI140A841/4	1/4"	4-1/4"	.401
ATI140A-10	5/16"	3-1/2"	.401
ATI140A-12	3/8"	4-1/2"	.401
ATI140B-6	3/16"	3-1/2"	.498
ATI140B-8	1/4"	3-1/2"	.498
ATI140B-10	5/16"	3-1/2"	.498
ATI140B-12	3/8"	4-1/2"	.498



Standard Knockout Punch

KNOCK-OUT PUNCH, STANDARD

Part Number	Rivet Size	Length	Shank Diameter
ATI141A33/32	3/32"	3-1/2"	.401
ATI141A31/8	1/8"	3-1/2"	.401
ATI141A35/32	5/32"	3-1/2"	.401
ATI141A33/16	3/16"	3-1/2"	.401
ATI141A37/32	7/32"	3-1/2"	.401
ATI141A31/4	1/4"	3-1/2"	.401
ATI141A35/16	5/16"	3-1/2"	.401
ATI141A33/8	3/8"	3-1/2"	.401
ATI141B33/16	3/16"	3-1/2"	.498
ATI141B31/4	1/4"	3-1/2"	.498
ATI141B35/16	5/16"	3-1/2"	.498
ATI141B33/8	3/8"	3-1/2"	.498



SKIN WEDGE

Commonly referred to as Superman's fingernail, this durable skin wedge tool is perfect for separating two pieces of sheet metal. Made from 4140 steel and heat-treated to allow slight flexibility.

Part Number	Material	Length	Width	Thickness
ATI14085	4140	7"	1"	1/4"

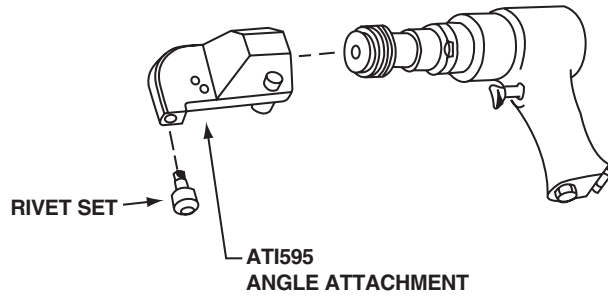

90° RIVET HAMMER ANGLE ATTACHMENT
ATI595 SERIES

A production aid for driving rivets in extremely hard-to-reach places. This 90° tool is a small, compact rivet gun attachment weighing only 16 oz. complete. It has 5/32" rivet capacity and uses ATI standard ATI1757 and ATI1758 Series rivet sets. Using the standard short set, this tool will reach into an opening 2-1/2" high.



Part Number	Shank Diameter	Thread Pitch (TPI)	For Use With:
ATI595B	.401	7	Ingersoll-Rand, Jiffy, Sioux
ATI595C	.401	8	ATI, Cleco, Chicago Pneumatic
ATI595BK	Angle attachment set includes ATI595B and 4 rivet sets in blue below		
ATI595CK	Angle attachment set includes ATI595C and 4 rivet sets in blue below		

RIVET SETS, CUPPED-TYPE
ATI1757 SERIES

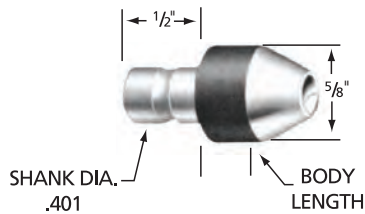

RIVET SETS, FLUSH-TYPE
ATI1758 SERIES

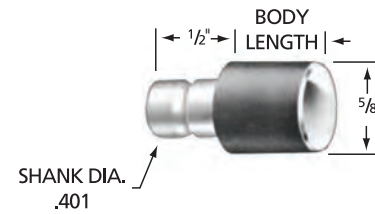

Part Number	Rivet Size	Rivet Type	Body Length	Shank Diameter
ATI1757AP332	3/32"	AN470	1/4"	.401
ATI1757AP1/8	1/8"	AN470	1/4"	.401
ATI1757AP532	5/32"	AN470	1/4"	.401
ATI1757AP316	3/16"	AN470	1/4"	.401
ATI1758AP	FLUSH	FLUSH	1/4"	.401
ATI1758AR	FLUSH	FLUSH	3/8"	.401
ATI1758AS	FLUSH	FLUSH	1/2"	.401

Included in ATI595BK and ATI595CK Sets

GOOSENECK-TYPE ADAPTER AND EXTENSION

ATI134GA

Originally designed for interchangeable inserts for Hi-Shear® collars, this unique adapter also accommodates Jiffy sets, ATI1757 & ATI1758 Series rivet sets, and standard .401 shank diameter rivet sets.

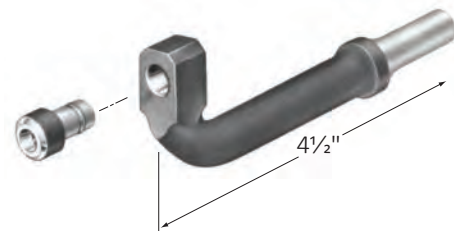

RIVET HAMMERS

- Aluminum offset pistol grip
- Teasing trigger for precise control
- Includes air flow valve, beehive spring, and quick-release retainer spring

Part Number	Aluminum Rivet Capacity	Steel Rivet Capacity	BPM	Length	Weight	Shank Diameter
ATIU-2X	5/32"	3/32"	2580	6-1/2"	2.25 lbs.	.401
ATIATC3X	3/16"	5/32"	2160	7-1/4"	2.25 lbs.	.401
ATIATC4X	1/4"	3/16"	1740	8-1/4"	2.75 lbs.	.401
ATIU5X	9/32"	3/16"	1560	8-1/4"	4.75 lbs.	.498
ATIU-7X	3/8"	5/16"	900	11-1/4"	6.00 lbs.	.498
ATIATU-9X	5/16"	1/4"	1140	9-1/4"	5.12 lbs.	.498



JIFFY TYPE RIVET HAMMERS

Use JAT100A and JAT101A Series Jiffy type rivet sets

Part Number	Aluminum Rivet Capacity	Steel Rivet Capacity	BPM	Length	Weight	Shank Diameter
ATI17-100B	5/32"	1/8"	2850	3-3/4"	2.25 lbs.	.401
ATI17-200B	3/16"	5/32"	2700	4-1/4"	2.62 lbs.	.401



RETAINER SPRINGS

ATI114C-3 QUICK RELEASE

- Fast thumb release to quickly change rivet sets
- Works with any 3x or 4x rivet hammer
- Accommodates 1/2" or 9/16" body diameter rivet sets



ATI115 BEEHIVE TYPE

Fixed type retainer spring for maximum safety.

ATI115A	For 1/2" body diameter rivet sets
ATI115B	For 5/8" body diameter rivet sets



The two types of rivet shields illustrated have been designed to provide additional skin protection when flush riveting. Both units are manufactured with heat-treated and polished faces.

Part Number	Shield Diameter
ATI117R	2"
ATI117RB-3	2" with 1/2" cut-away relief

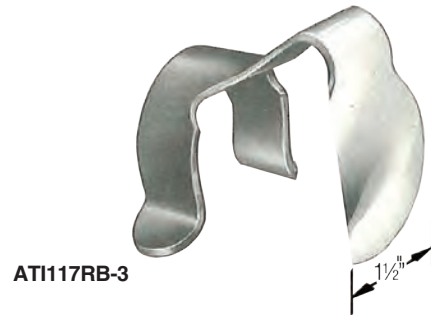
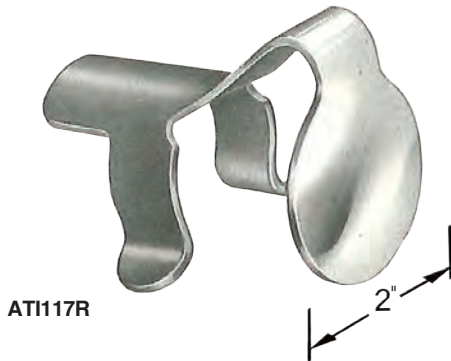

RIVET SET EXTENSION ADAPTER

.401 Shank; .401 Recess

Part Number	OAL
ATI124A-4	4"
ATI124A-6	8"
ATI124A-12	12"



SHANK ADAPTERS



This sleeve nests in the barrel of the rivet hammer, easily converting .498 bore diameter to .401.



ATI124B-3
Converts .401 shank rivet sets to .498. Use 5X, 9X, and 7X guns with .401 tools.

GRIP GAUGES

ATI269C3 & ATI2612

Simple, self-explanatory gauges determine material thickness and proper rivet grip length.



SAFETY PRECAUTION: Read and follow all safety and operating instructions.
WARNING: Face & eye protection must be worn while operating power tools, per ANSI B186.1

RIVETING TOOLS AND ACCESSORIES

SHEET-METAL TOOL KITS AND RIVET CUTTERS



These kits provide the essentials for straight and offset riveting. Ideal for structural and sheet-metal technicians, home builders, and students. Plastic zipped carrying case for tool control and FOD prevention.

ATI590RGK3X	WITH ATIATC3X RIVET GUN
ATI590RGK-4X	WITH ATIATC4X RIVET GUN

Kit includes:

1	RIVET HAMMER	1	ATI101AF-3A
1	ATI100A33/32	1	ATI107A-2
1	ATI100A3-1/8	1	ATI110CB
1	ATI100A35/32	1	ATI114C-3
1	ATI100A33/16	1	ATI638
1	ATI101A33/32	1	ATI647
1	ATI100A3-1/8	1	ATI670
1	ATI101A35/32	1	ATI681
1	ATI101A3316	1	A-1142 (oil)



ATI590RGK-4X
Clear zipper case included

ATI590SMKSP1	WITH SIOUX 270 RIVET GUN
ATI590SMKSP6	WITH ATIATC4X RIVET GUN

- Four straight AN470 universal rivet sets (3/32", 1/8", 5/32", 3/16")
- One flush rivet set
- Four integral pilot countersinks (#10, #21, #30, #40) pilot sizes
- Microstop-ball bearing
- Hand rivet cutter
- Rivet hammer (see chart)
- Four spring tension u-clamps
- 12 Each (3/32", 1/8", 5/32", 3/16") temporary fasteners
- Sioux SDR4P26N2 drill
- Jobber drills- 3/32", 1/8", 5/32", 3/16", #40, #30, #21, #10
- Drill stops- #10, #21, #30, #40
- Sheet holder pliers
- Bucking Bar
- Retainer spring-quick release



ATI590SMKSP1



ATI501R

This rivet cutter is designed to quickly and easily shear aluminum rivets. It is adjustable for 1/4" to 3/4" long rivets in 1/16" increments, for rivet sizes 3/32", 1/8", 5/32", 3/16", 7/32", and 1/4".



ATI501S

This rivet cutter, with 13" tubular handles for additional leverage, was developed for the U.S. Government.



SAFETY PRECAUTION: Read and follow all safety and operating instructions.

WARNING: Face & eye protection must be worn while operating power tools, per ANSI B186.1

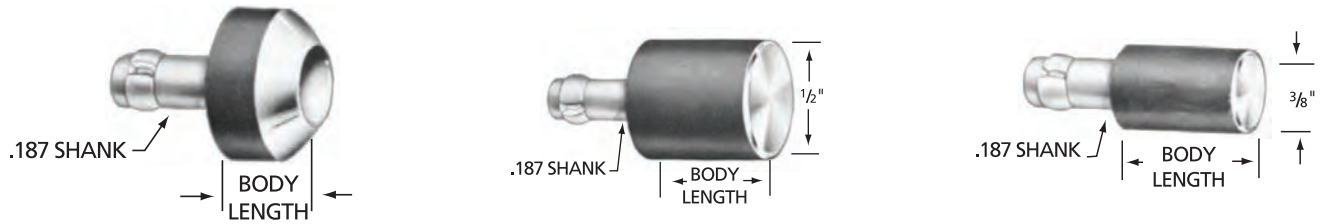

Rivet Size	Rivet Type	Body Diameter	Shank Diameter	1/8" BODY LENGTH	1/4" BODY LENGTH	3/8" BODY LENGTH	1/2" BODY LENGTH	5/8" BODY LENGTH	3/4" BODY LENGTH
3/32"	AN470	3/8"	.187	ATI108AN3/32	ATI108AP3/32	ATI108AR3/32	ATI108AS3/32	ATI108AT3/32	ATI108AW3/32
1/8"	AN470	3/8"	.187	ATI108AN1/8	ATI108AP1/8	ATI108AR1/8	ATI108AS1/8	ATI108AT1/8	ATI108AW1/8
5/32"	AN470	1/2"	.187	ATI108AN5/32	ATI108AP5/32	ATI108AR5/32	ATI108AS5/32	ATI108AT5/32	ATI108AW5/32
3/16"	AN470	1/2"	.187	ATI108AN3/16	ATI108AP3/16	ATI108AR3/16	ATI108AS3/16	ATI108AT3/16	ATI108AW3/16
1/4"	AN470	5/8"	.187	ATI108AN1/4	ATI108AP1/4	ATI108AR1/4	ATI108AS1/4	ATI108AT1/4	ATI108AW1/4
3/32"	AN470	3/8"	.250	ATI108BN3/32	ATI108BP3/32	ATI108BR3/32	ATI108BS3/32	ATI108BT3/32	ATI108BW3/32
1/8"	AN470	3/8"	.250	ATI108BN1/8	ATI108BP1/8	ATI108BR1/8	ATI108BS1/8	ATI108BT1/8	ATI108BW1/8
5/32"	AN470	1/2"	.250	ATI108BN5/32	ATI108BP5/32	ATI108BR5/32	ATI108BS5/32	ATI108BT5/32	ATI108BW5/32
3/16"	AN470	1/2"	.250	ATI108BN3/16	ATI108BP3/16	ATI108BR3/16	ATI108BS3/16	ATI108BT3/16	ATI108BW3/16
1/4"	AN470	5/8"	.250	X	ATI108BP1/4	ATI108BR1/4	ATI108BS1/4	ATI108BT1/4	X
FLUSH	FLUSH	1/2"	.187	ATI109AN	ATI109AP	ATI109AR	ATI109AS	ATI109AT	ATI109AW
FLUSH	FLUSH	3/8"	.187	ATI109EN	ATI109EP	ATI109ER	ATI109ES	ATI109ET	ATI109EW
FLUSH	FLUSH	1/2"	.250	ATI109BN	ATI109BP	ATI109BR	ATI109BS	ATI109BT	ATI109BW

Included in 33 Piece Kit

Included in 16 Piece Kit

RIVET SQUEEZER SETS FOR MODIFIED UNIVERSAL HEAD RIVETS, BACR15FT

Rivet Size	Rivet Type	Body Diameter	Shank Diameter	1/8" BODY LENGTH	1/4" BODY LENGTH	3/8" BODY LENGTH	1/2" BODY LENGTH	5/8" BODY LENGTH	3/4" BODY LENGTH
5/32"	BACR15FT	1/2"	.187	ATI108AN532F	ATI108AP532F	ATI108AR532F	ATI108AS532F	ATI108AT532F	ATI108AW532F
3/16"	BACR15FT	1/2"	.187	ATI108AN316F	ATI108AP316F	ATI108AR316F	ATI108AS316F	ATI108AT316F	ATI108AW316F
1/4"	BACR15FT	5/8"	.187	ATI108AN1/4F	ATI108AP1/4F	ATI108AR1/4F	ATI108AS1/4F	ATI108AT1/4F	X

RIVET SQUEEZER KITS

ATI108A33PC

- 33 Piece set for installing universal (AN470) and flush (AN426) rivets
- 3/16" Diameter shank with lock ring
- Universal (AN470) cup sizes 3/32", 1/8", 5/32", 3/16" and 1/4"
- Body lengths of 1/8", 1/4", 3/8", 1/2" and 5/8"
- Suitable for either hand or pneumatic squeezers
- See chart above for squeezer sets included

ATI108A-16PC

- 16 Piece set for installing universal (AN470) and flush (AN426) rivets
- 3/16" Diameter shank with lock ring
- Universal (AN470) cup sizes 3/32", 1/8", 5/32", 3/16" and 1/4"
- Body lengths of 1/8", 1/4", 3/8", 1/2" and 5/8"
- Suitable for either hand or pneumatic squeezers
- See chart above for squeezer sets included



ATI108A33PC



SAFETY PRECAUTION: Read and follow all safety and operating instructions.
WARNING: Face & eye protection must be worn while operating power tools, per ANSI B186.1

RIVETING TOOLS AND ACCESSORIES

HAND RIVET SQUEEZERS



ATI501A - ALLIGATOR-TYPE HAND RIVET SQUEEZER

- 3/32" - 5/32" rivet capacity
- 2 -1/2" reach
- 1-1/8" gap
- 18" handles for ample leverage
- Accepts 3/16" diameter shank rivet squeezer sets and cold dimple dies



ATI501A

C-TYPE SWIVEL YOKE HAND RIVET SQUEEZERS

- 3/32" - 5/32" rivet capacity
- 3/8" stroke
- 5/8" ram adjustment to eliminate shims
- 360 degree swivel yoke can be locked in any position
- Accepts 3/16" diameter shank rivet squeezer sets and cold dimple dies

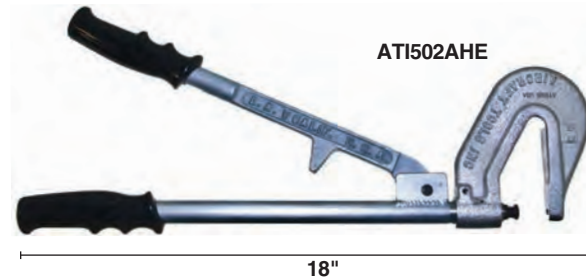

Part Number	Reach	Closed Gap
ATI502AHD	1-1/2"	1-5/8"
ATI502AHE	3"	1-1/2"
ATI502D	1-1/2"	YOKE ONLY
ATI502E	3"	YOKE ONLY

360° SWIVEL YOKE ATTACHMENTS

The ATI502 Swivel Yokes are furnished with attachment plates to fit the CP214 or equivalent air motor. This unit has a built-in ram adjustment which eliminates the need for washers to adjust the length of the squeezer and will automatically lock in the required position. The yoke can also be locked in any position in the full 360° swing. Uses standard squeezer sets with 3/16" shank diameter.



*Does not include power unit

Part Number	Yoke Depth
ATI502YA	1-1/2"
ATI502YB	3"

PNEUMATIC RIVET SQUEEZERS

PNEUMATIC RIVET SQUEEZER, ALLIGATOR AND C-TYPE

Use 3/16" shank squeezer sets, refer to ATI108 & ATI109 Series

Part Number	Yoke Style	Cylinder Type	Yoke Reach	Force	Aluminum Rivet Capacity	Steel Rivet Capacity	Overall Length	Weight With Jaws
ATI114A	ALLIGATOR	SINGLE	1-1/2"	3000 lbs	1/8"	3/32"	9-1/4"	4 lbs.
ATI114A214	ALLIGATOR	SINGLE	2-1/4"	2200 lbs	3/32"	3/32"	10-1/8"	4-1/2 lbs.
ATI114A-3	ALLIGATOR	SINGLE	3"	1800 lbs	3/32"	1/16"	10-7/8"	5 lbs.
ATI114TA	ALLIGATOR	TANDEM	1-1/2"	6000 lbs	3/16"	5/32"	12"	5-1/2 lbs.
ATI114TA214	ALLIGATOR	TANDEM	2-1/4"	4300 lbs	3/16"	1/8"	13"	6 lbs.
ATI114TA-3	ALLIGATOR	TANDEM	3"	3400 lbs	5/32"	3/32"	14"	6-1/4 lbs.



ATI114A

Part Number	Yoke Style	Cylinder Type	Yoke Reach	Force	Aluminum Rivet Capacity	Steel Rivet Capacity	Overall Length	Weight With Jaws
ATI114C	C-TYPE	SINGLE	1-1/2"	3000 lbs	1/8"	3/32"	10-5/16"	4-1/2 lbs.
ATI114TC	C-TYPE	TANDEM	1-1/2"	6000 lbs	3/16"	5/32"	14"	5-1/2 lbs.



ATI114C



ATI BUCKING BARS ARE THE BEST VALUE AVAILABLE. HERE'S WHY:

All Bucking surfaces are flat and polished to a minimum 63 finish after heat treat.

ATI offers the largest selection of different configured bars available.

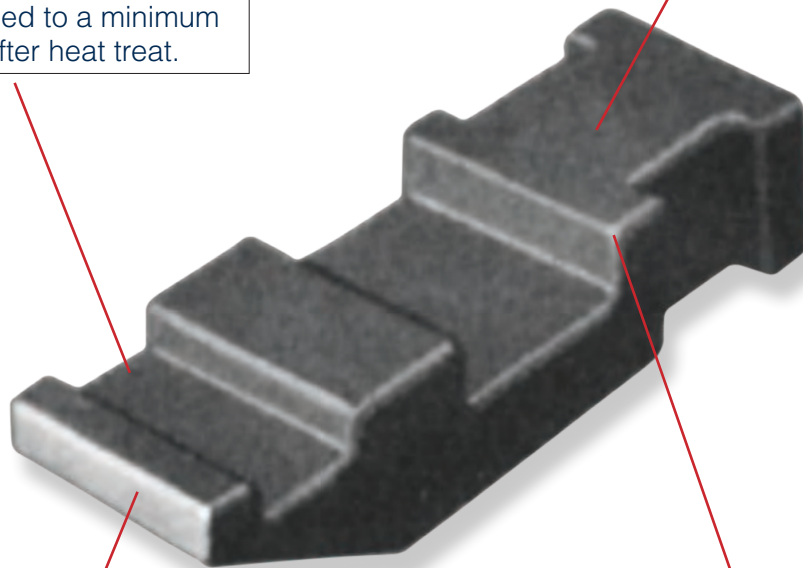

All Bucking surfaces are dipped in clear plastic to prevent damage during shipment and storage.

All sharp corners and edges are radiused 1/32"-1/16" to prevent skin damage.

BUCKING BARS

BUCKING BARS, TUNGSTEN



- High density tungsten absorbs bucking impact
 - Reduces vibration and minimizes bucking bar movement when riveting
 - Sharp edges are radiused up to 1/16" to prevent skin damage
 - Smaller configured design provides enhanced bucking in tight areas
- Custom designed tungsten bars may be available upon special request.

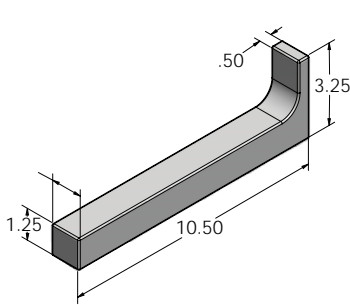

ATI613T
9.0 LBS

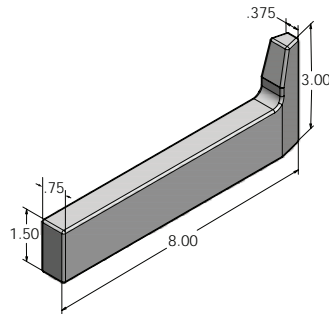

ATI614T
8.0 LBS

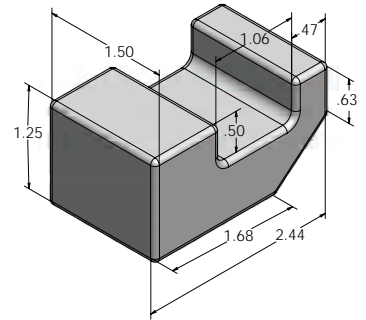

ATI634T
1.6 LBS

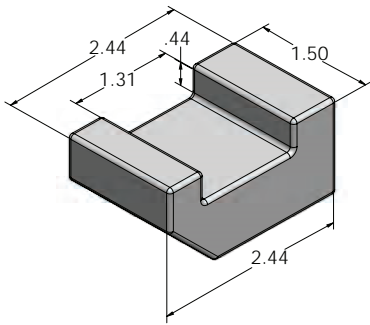

ATI634TX
1.4 LBS

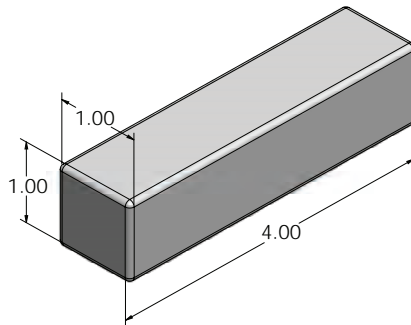

ATI729-3T
1.55 LBS

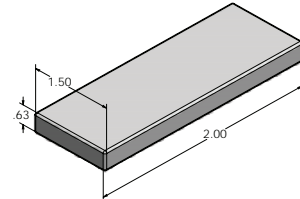

ATI729-13T
1.2 LBS

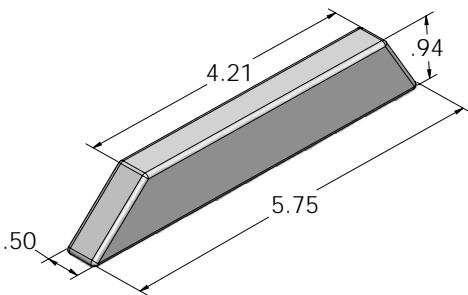

ATI732T
2.11 LBS

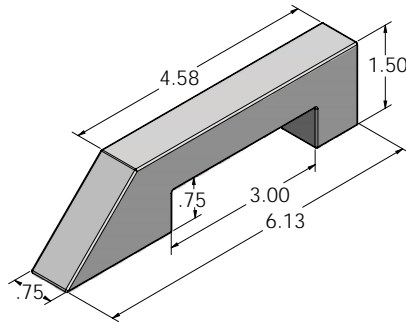

ATI760B-2T
2.85 LBS

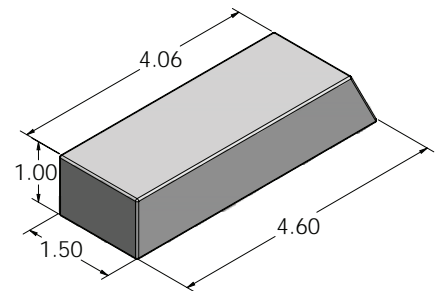

ATI760B-10T
5.5 LBS

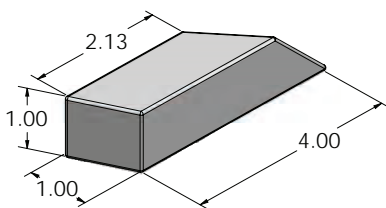

ATI760B-10TX
1.92 LBS

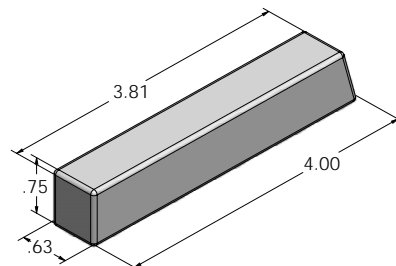

ATI760B-10TXX
1.25 LBS

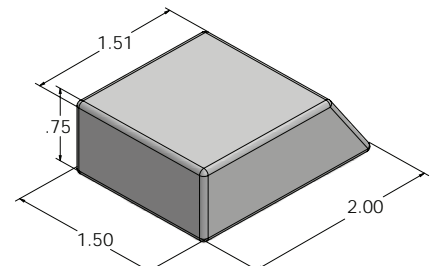

ATI764T
1.3 LBS



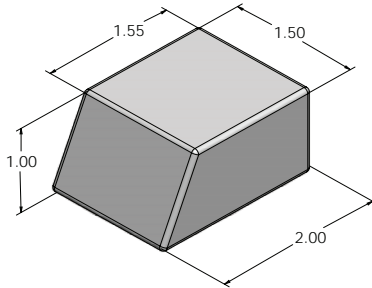

»»» ATI765T
1.75 LBS

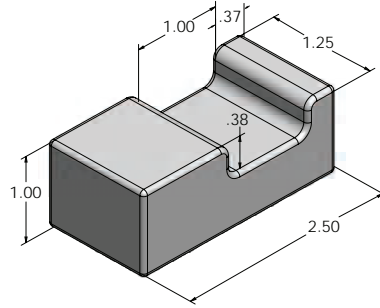

»»» ATI766T
1.7 LBS

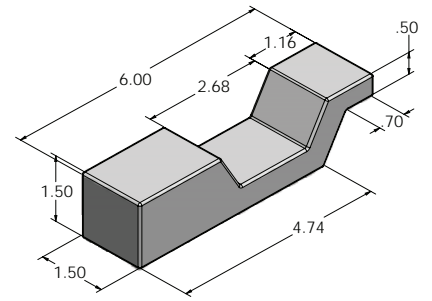

»»» ATIETBB08
6.0 LBS

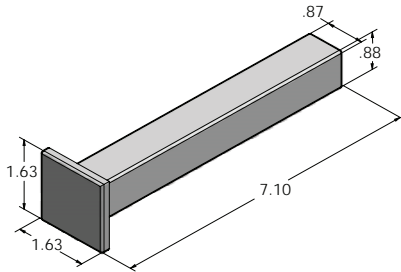

»»» ATIETBB10
3.85 LBS

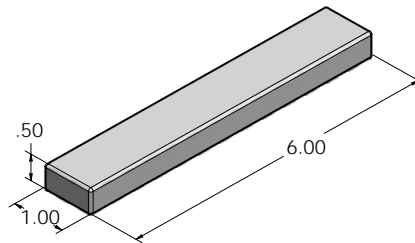

»»» ATIETBB20
1.95 LBS

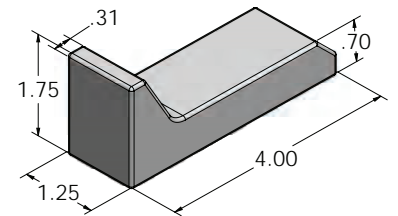

»»» ATIETBB22
2.90 LBS

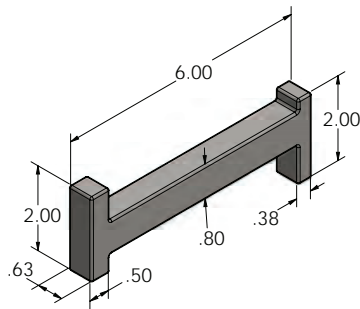

»»» ATIETBB23
2.40 LBS

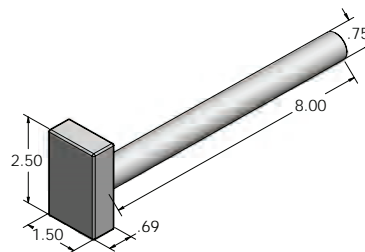

»»» ATIETBB24
4.05 LBS

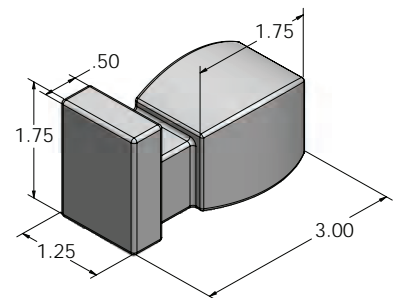

»»» ATIETBB25
3.15 LBS

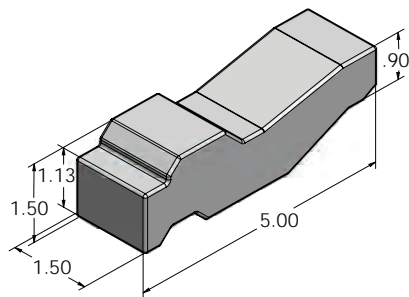

»»» ATIETBB37
5.75 LBS

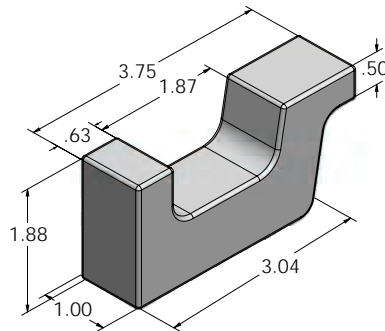

»»» ATIETBB40
3.05 LBS

BUCKING BARS

BUCKING BARS, STANDARD



- All bucking surfaces are polished to a minimum 63 finish after heat treat
- All sharp corners and edges are radiused 1/32"-1/16" to prevent skin damage
- All bucking surfaces are dipped in clear plastic to prevent damage during shipment and storage

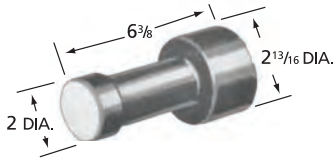

»»» ATi601
6.00 LBS

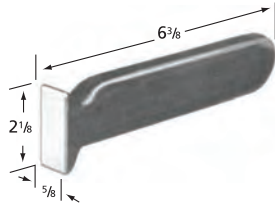

»»» ATi602
1.25 LBS

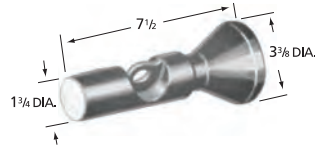

»»» ATi603
6.50 LBS

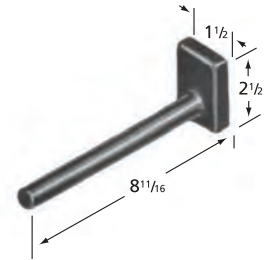

»»» ATi604
1.75 LBS

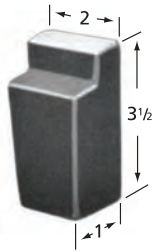

»»» ATi605
1.50 LBS

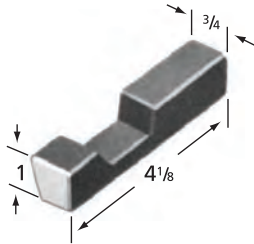

»»» ATi606
0.75 LBS

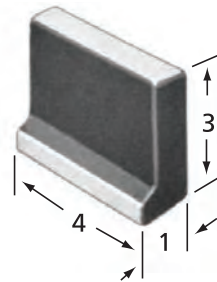

»»» ATi607
2.50 LBS

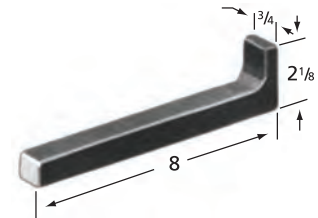

»»» ATi608
1.25 LBS

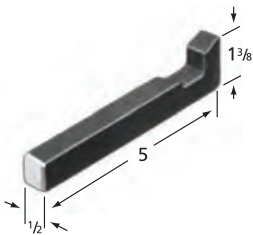

»»» ATi609
0.50 LBS

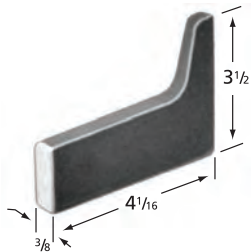

»»» ATi610
0.75 LBS

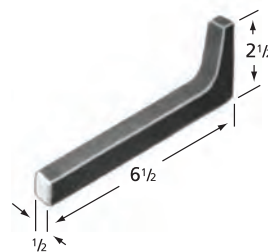

»»» ATi611
1.00 LBS

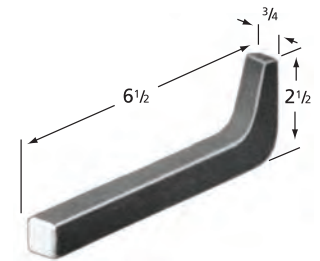

»»» ATi612
1.25 LBS

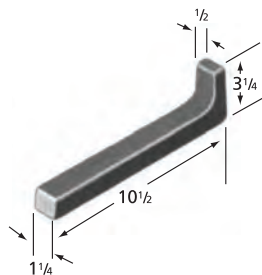

»»» ATi613
5.50 LBS

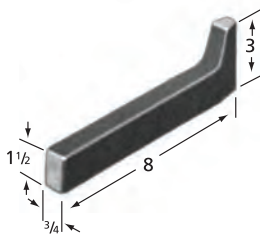

»»» ATi614
2.75 LBS

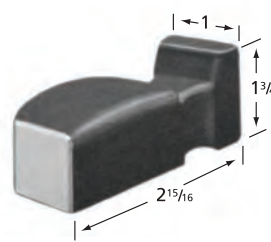

»»» ATi616
1.00 LBS

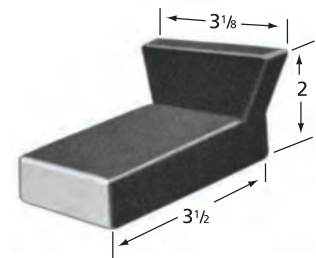

»»» ATi618
2.25 LBS



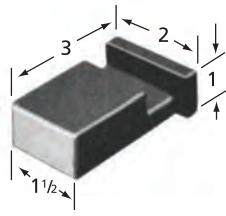

ATI619
1.25 LBS

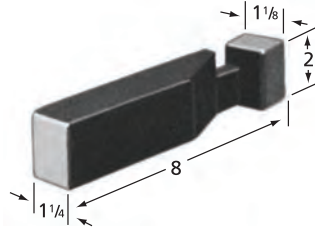

ATI620
4.50 LBS

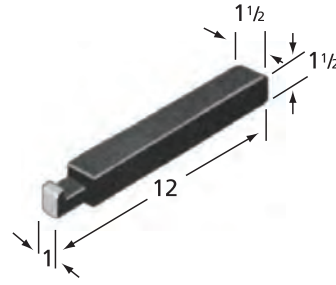

ATI621
7.00 LBS

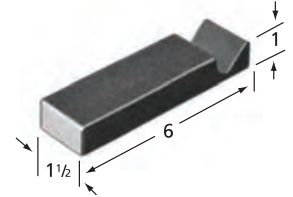

ATI622
2.50 LBS

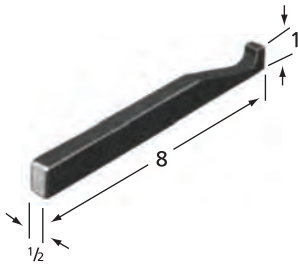

ATI624
1.00 LBS

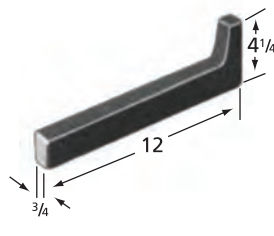

ATI625
5.25 LBS

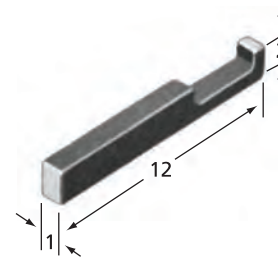

ATI626
6.00 LBS

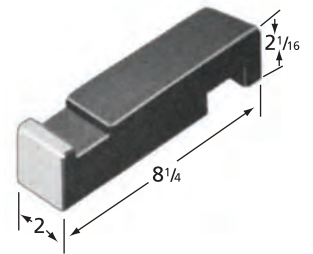

ATI627
7.75 LBS

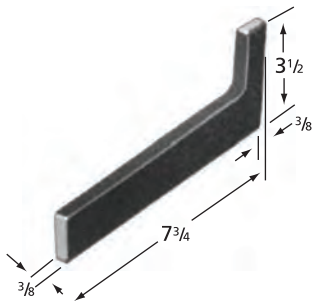

ATI628
1.50 LBS

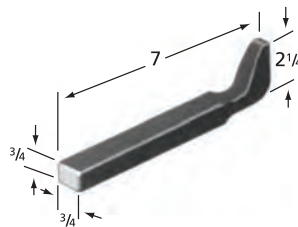

ATI629
1.00 LBS

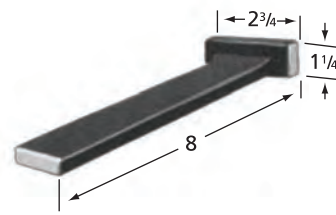

ATI630
1.50 LBS

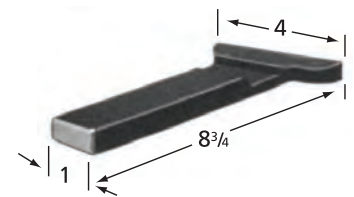

ATI632
4.50 LBS

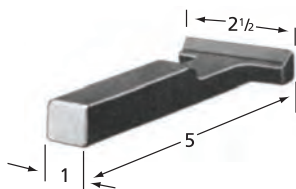

ATI633
1.50 LBS

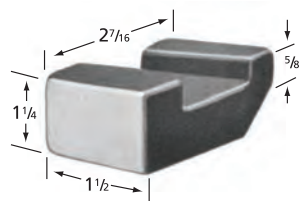

ATI634
1.00 LBS

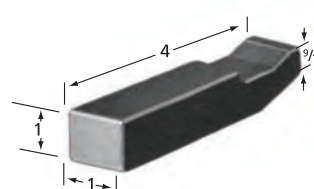

ATI636
1.00 LBS

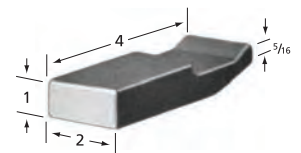

ATI637
1.75 LBS

BUCKING BARS
BUCKING BARS, STANDARD

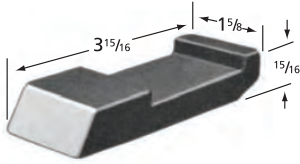

ATI638
1.25 LBS

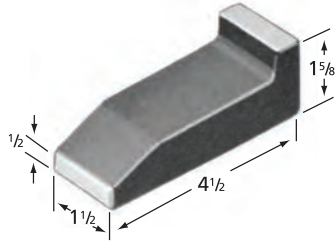

ATI639
2.00 LBS

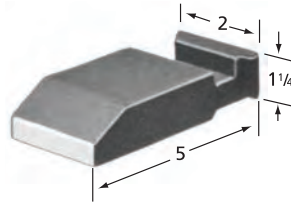

ATI640
3.00 LBS

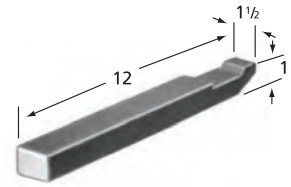

ATI641
4.75 LBS

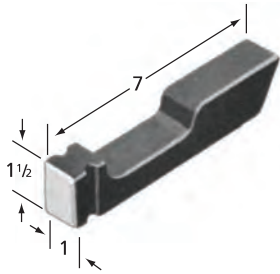

ATI642
2.50 LBS

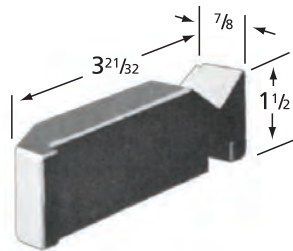

ATI643
1.25 LBS

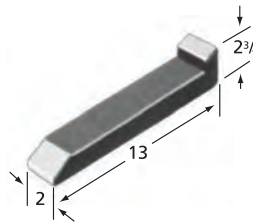

ATI644
11.75 LBS

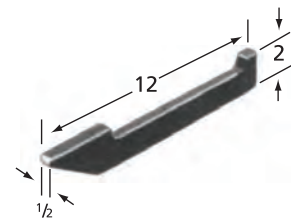

ATI646
2.25 LBS

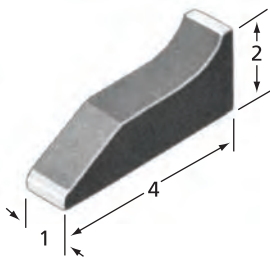

ATI647
1.50 LBS

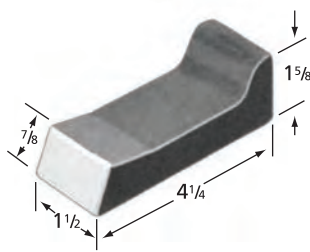

ATI648
1.50 LBS

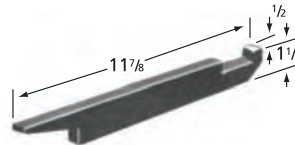

ATI649
2.00 LBS

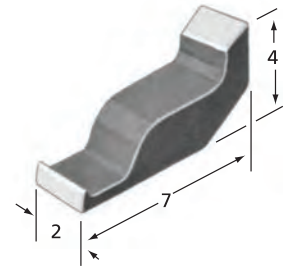

ATI652
6.00 LBS

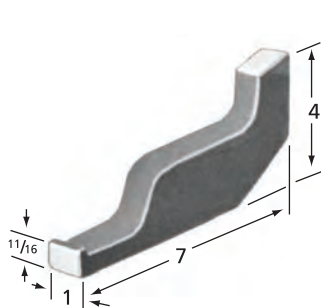

ATI653
3.00 LBS

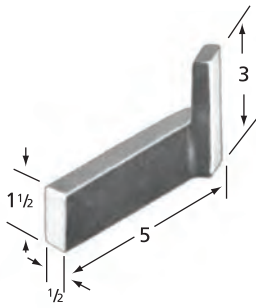

ATI656
1.25 LBS

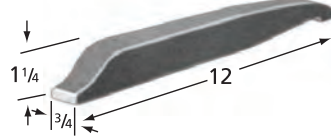

ATI657
3.00 LBS

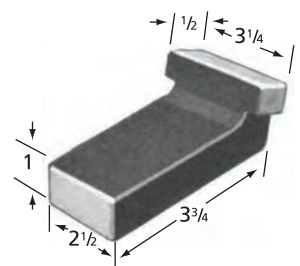

ATI658
3.75 LBS



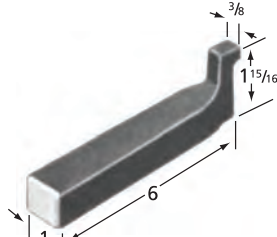

ATI659
1.50 LBS

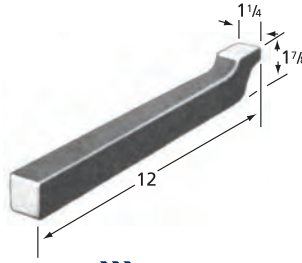

ATI661
5.25 LBS

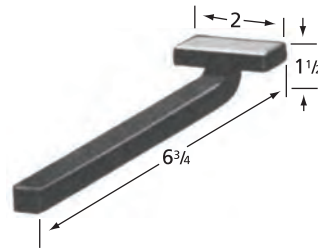

ATI662
0.75 LBS

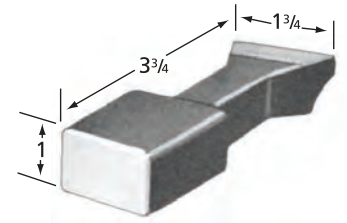

ATI664
1.25 LBS

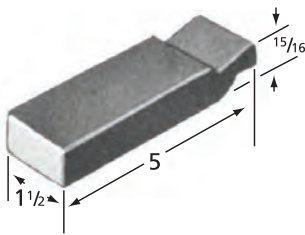

ATI665
2.00 LBS

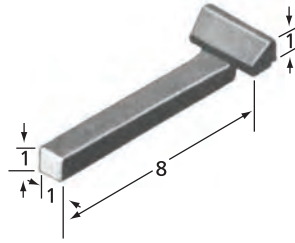

ATI668
3.00 LBS

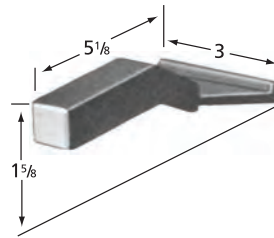

ATI669
1.50 LBS

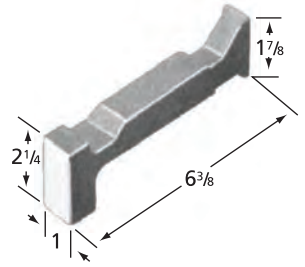

ATI670
2.00 LBS

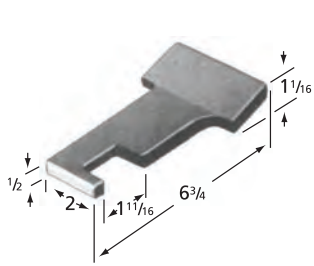

ATI671
2.25 LBS

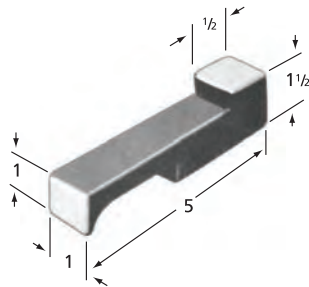

ATI672
1.25 LBS

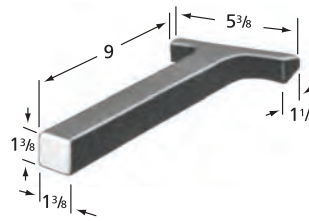

ATI674
6.25 LBS

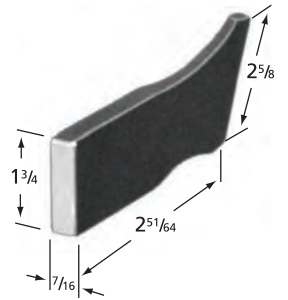

ATI676
0.75 LBS

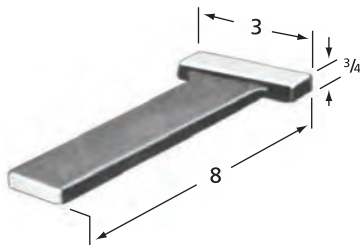

ATI678
1.75 LBS

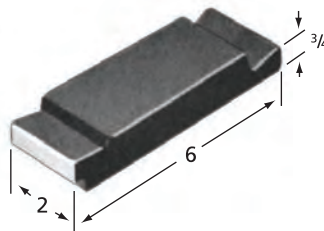

ATI679
3.00 LBS

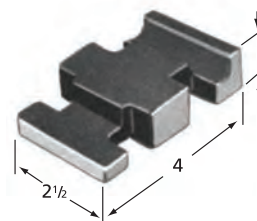

ATI680
2.00 LBS

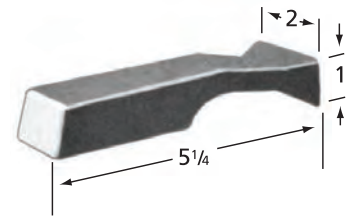

ATI681
1.50 LBS

BUCKING BARS
BUCKING BARS, STANDARD

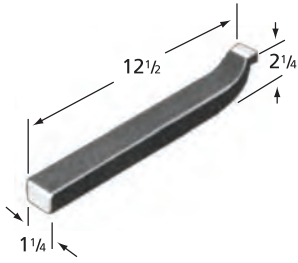

ATI682
5.50 LBS

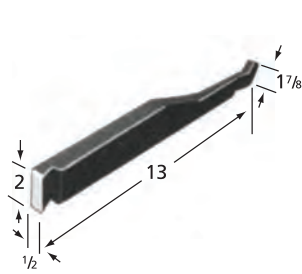

ATI683
3.00 LBS

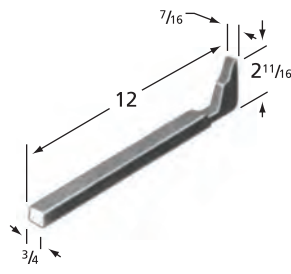

ATI685
2.00 LBS

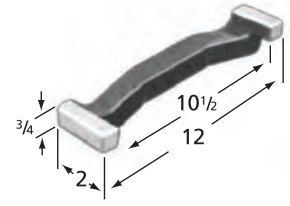

ATI686
4.00 LBS

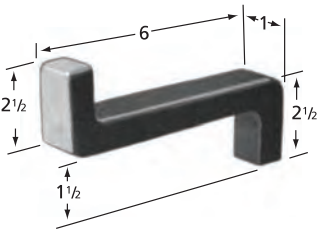

ATI690
2.50 LBS

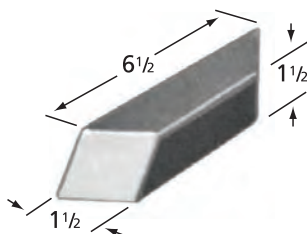

ATI692
3.25 LBS

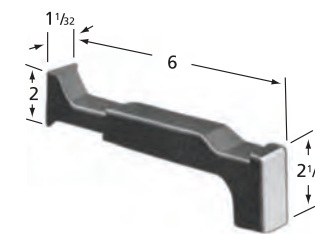

ATI694
2.00 LBS

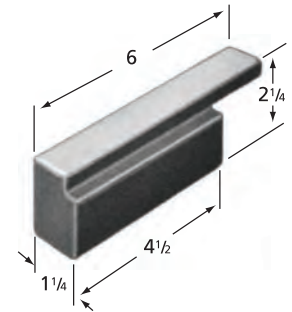

ATI698
3.50 LBS

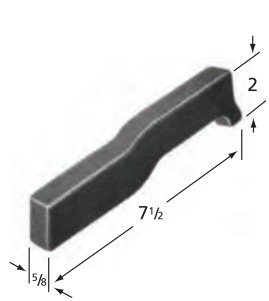

ATI700
2.00 LBS

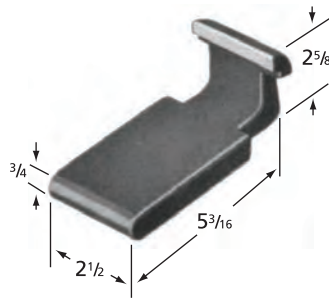

ATI701
2.75 LBS

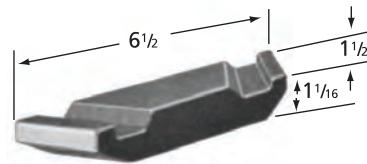

ATI702
2.00 LBS

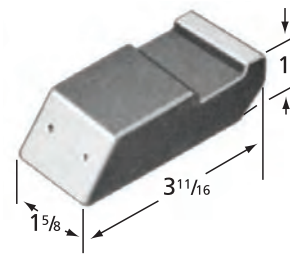

ATI707
1.50 LBS

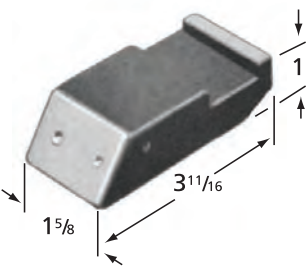

ATI708
1.50 LBS

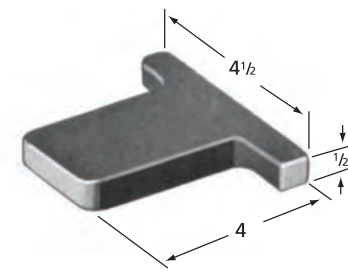

ATI711
1.25 LBS

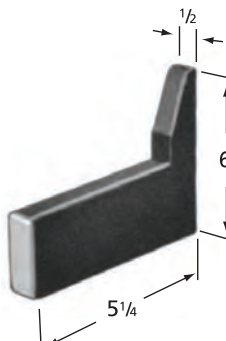

ATI715
2.00 LBS

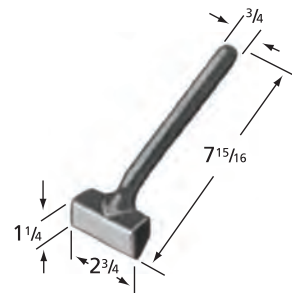

ATI718
1.50 LBS



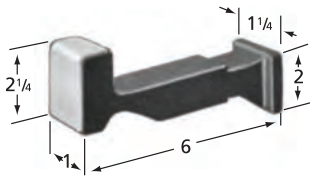

»»» ATI719
2.00 LBS

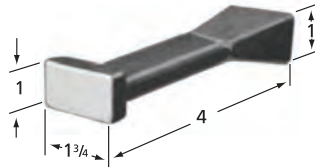

»»» ATI720
0.75 LBS

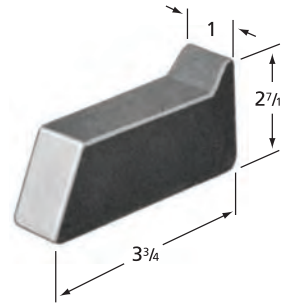

»»» ATI721
1.75 LBS

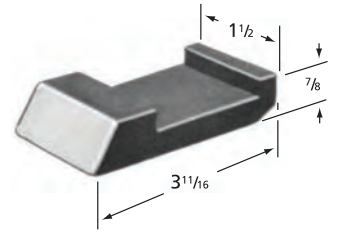

»»» ATI722
1.00 LBS

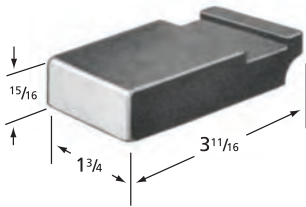

»»» ATI723
1.25 LBS

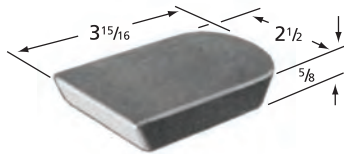

»»» ATI724
1.50 LBS



»»» ATI725
2.00 LBS

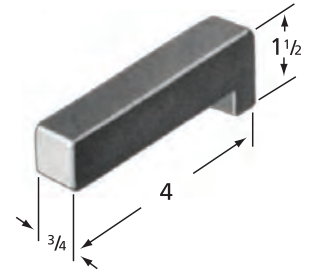

»»» ATI727
1.00 LBS

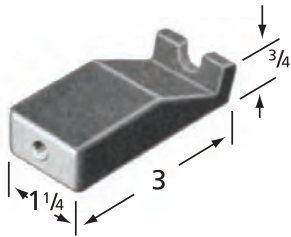

»»» ATI728
0.75 LBS

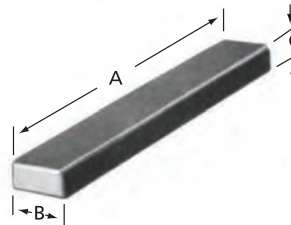

»»» ATI729-1
0.50 LBS

Part Number	A	B	C	Weight
ATI729-1	4"	1/2"	1/2"	0.50
ATI729-2	4"	3/4"	3/4"	0.75
ATI729-3	4"	1"	1"	1.00
ATI729-4	4"	1-1/2"	1-1/2"	2.50
ATI729-5	4"	2"	2"	4.50
ATI729-6	4"	1/2"	3/4"	0.25
ATI729-8	6"	1"	3/4"	1.25
ATI729-9	6"	2"	1"	3.50

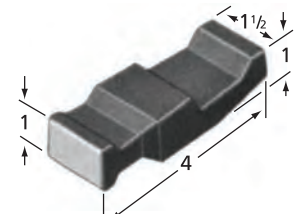

»»» ATI730
1.25 LBS

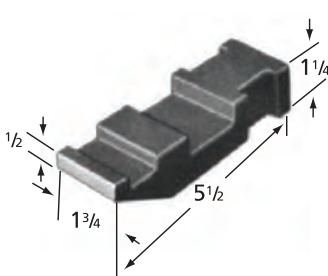

»»» ATI731
2.25 LBS

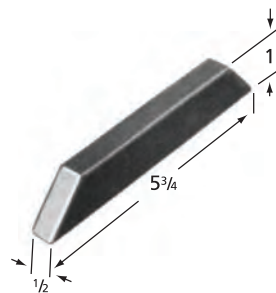

»»» ATI732
0.75 LBS

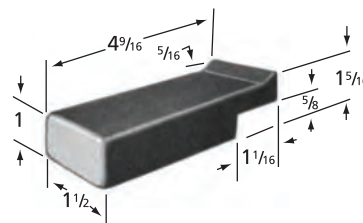

»»» ATI735
1.75 LBS

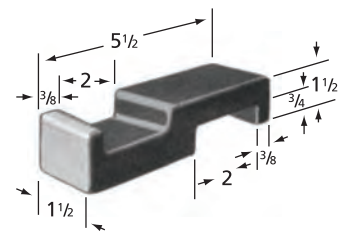

»»» ATI736
2.25 LBS



SAFETY PRECAUTION: Read and follow all safety and operating instructions.
WARNING: Face & eye protection must be worn while operating power tools, per ANSI B186.1

BUCKING BARS
BUCKING BARS, STANDARD

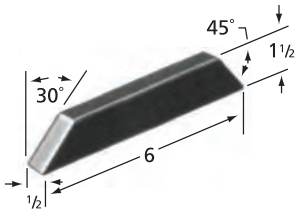

ATI737
1.00 LBS

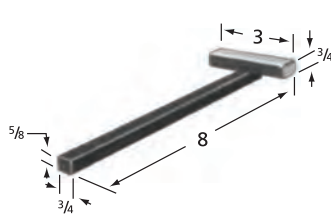

ATI750D-23
1.75 LBS

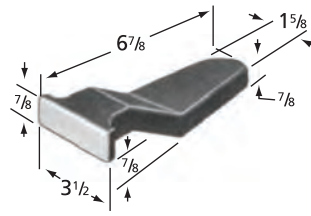

ATI750E-1
3.25 LBS

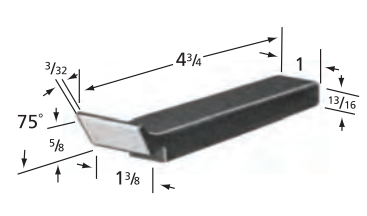

ATI750K-1
1.00 LBS

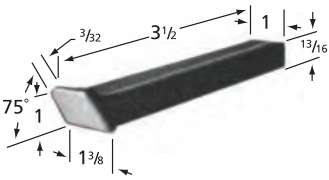

ATI750K-2
1.25 LBS

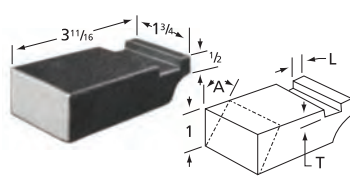

ATI750J-5
1.75 LBS

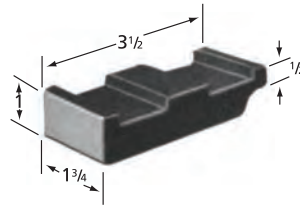

ATI750J-51
1.50 LBS

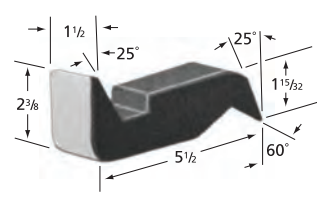

ATI750P-3
2.75 LBS

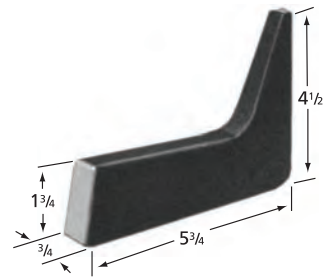

ATI750N-1
2.50 LBS

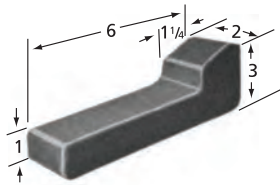

ATI750N-26
4.75 LBS

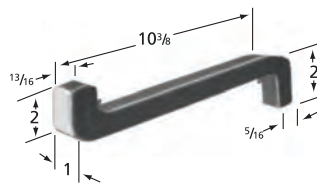

ATI750S-1
2.75 LBS

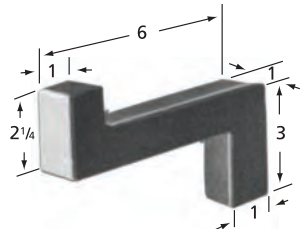

ATI750S-61
2.75 LBS

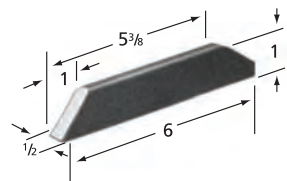

ATI750T-1
0.75 LBS

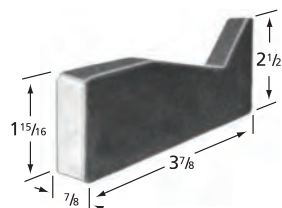

ATI750U-1
2.00 LBS

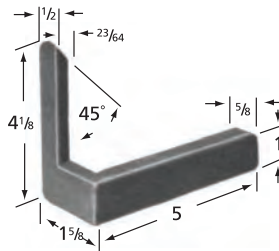

ATI750V-1
1.25 LBS

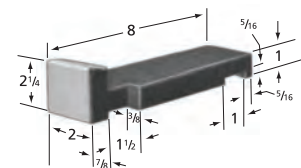

ATI750Y-1
4.50 LBS



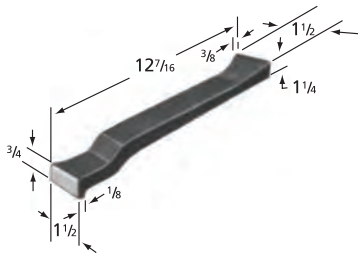

»»» ATI750Z-1
2.75 LBS

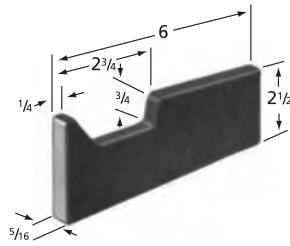

»»» ATI751B-21
1.25 LBS

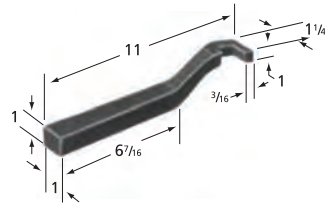

»»» ATI751K-1
3.00 LBS

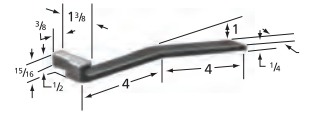

»»» ATI751L-4
0.50 LBS

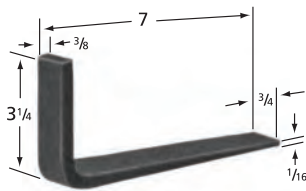

»»» ATI751R-H
0.50 LBS

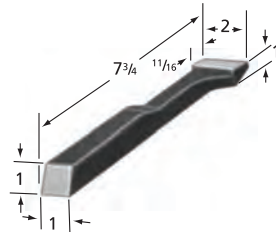

»»» ATI751U-1
1.25 LBS

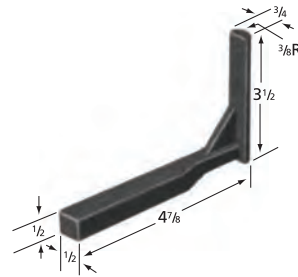

»»» ATI751V-1
1.25 LBS

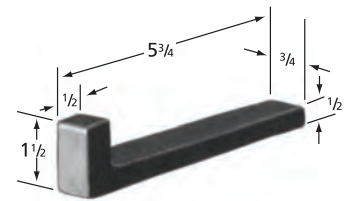

»»» ATI751Y-11
0.75 LBS

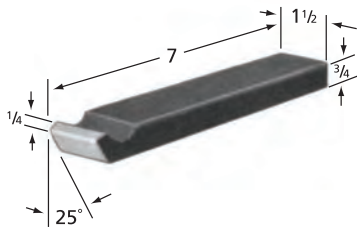

»»» ATI752A-1
2.25 LBS

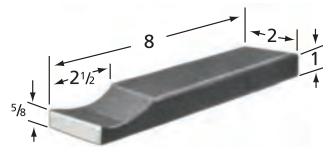

»»» ATI752B-1
4.00 LBS

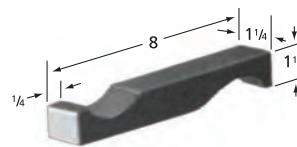

»»» ATI752C-1
2.50 LBS

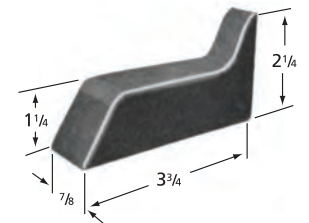

»»» ATI752F-1
1.25 LBS

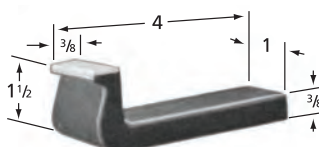

»»» ATI752P-1
0.50 LBS

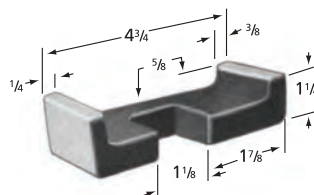

»»» ATI752T-1
1.00 LBS

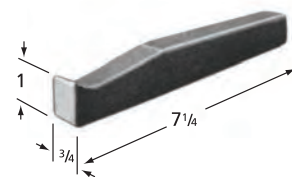

»»» ATI752V-1
1.62 LBS

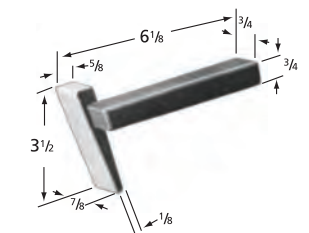

»»» ATI752Z-1
1.50 LBS

BUCKING BARS
BUCKING BARS, STANDARD

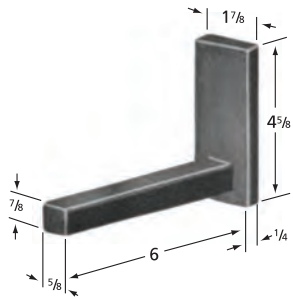

ATI753M-1
1.75 LBS

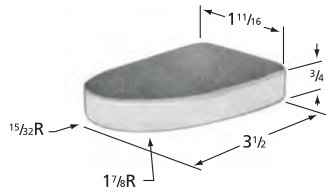

ATI753T-4
1.25 LBS

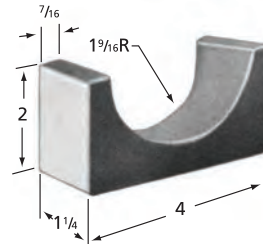

ATI760B-1
1.75 LBS

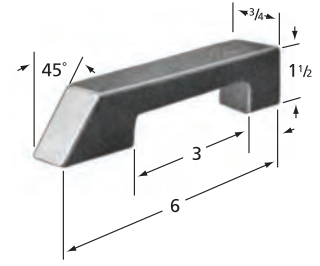

ATI760B-2
1.25 LBS

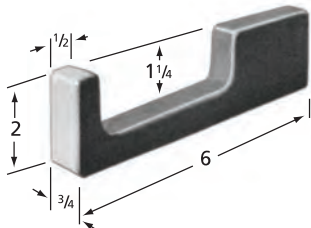

ATI760B-3
1.75 LBS

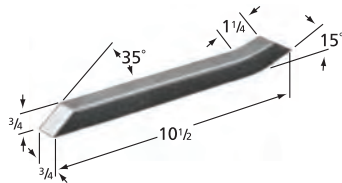

ATI760B-7
1.50 LBS

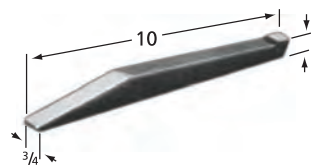

ATI760B-8
1.75 LBS

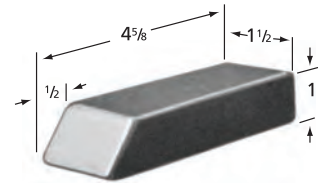

ATI760B-10
2.00 LBS

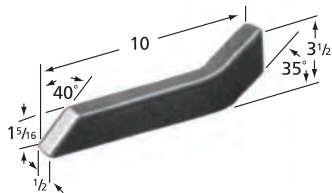

ATI760C-1
2.00 LBS

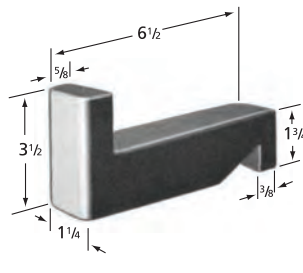

ATI761C-5
4.50 LBS

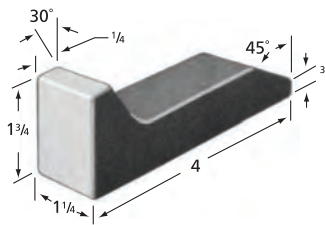

ATI763
1.25 LBS

BUCKING BAR SET, 4-PC

ATI590BBK

- Set includes 1 each: ATI638, ATI647, ATI670, ATI681

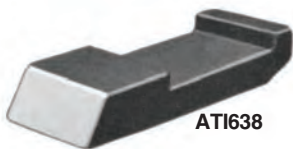

ATI638



ATI647



ATI670



ATI681



SAFETY PRECAUTION: Read and follow all safety and operating instructions.

WARNING: Face & eye protection must be worn while operating power tools, per ANSI B186.1

ATI's Trauma Reducing Bucking Bar significantly reduces vibration associated with hammering rivets. This unique design features an adjusting screw for increasing or decreasing spring tension, depending on the rivet size and material. The cushioned grip maximizes comfort and adds to the reduction of vibration. The quick-change design enables the changing of bars in seconds. These bucking bars may be used with either recoilless or conventional style Rivet Hammers.



ATI1001UK

The kit consists of five bucking bars, one handle assembly, and plastic carrying case.

Kit includes:

ATI1001A
ATI1001-8
ATI10019
ATI100110
ATI1001-11
ATI100112

ATI1001K

The kit consists of six bucking bars, one handle assembly, and plastic carrying case.

Kit includes:

ATI1001A
ATI1001-8
ATI10019
ATI100110
ATI1001-11
ATI100112
ATI100113

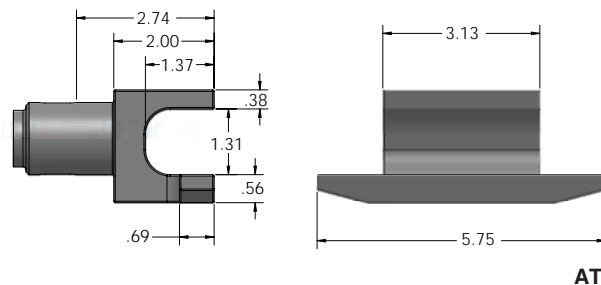
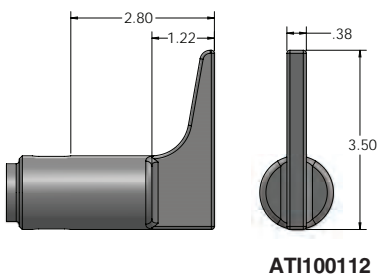
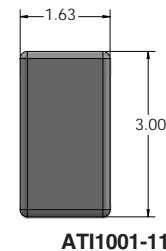
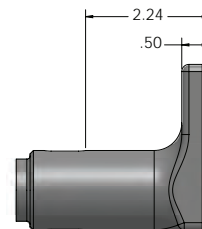
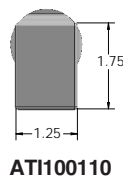
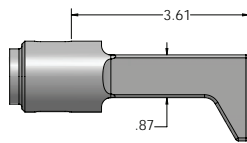
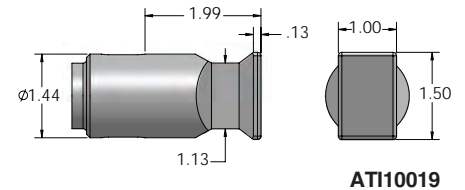
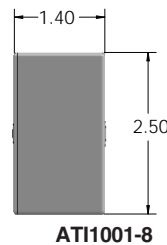
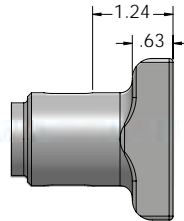
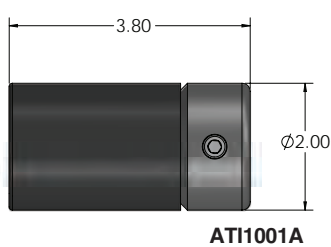

SAFETY PRECAUTION: Read and follow all safety and operating instructions.
WARNING: Face & eye protection must be worn while operating power tools, per ANSI B186.1

HOT AND COLD DIMPLING TOOLS AND EQUIPMENT

Since the inception of hot dimpling, ATI has been a prime supplier to government agencies and airframe industries throughout the world. Our flow-form method provides a sharp definition, superior strength and complete interne stability. The tools have been engineered to speed and facilitate dimpling production and to unite skill in operation. All hot dimple dies are made from high-grade tool steel, manufactured to precise tolerances, and hard-chrome plated to assure uniform heat transfer and long life.



COLD DIMPLE DIE KIT

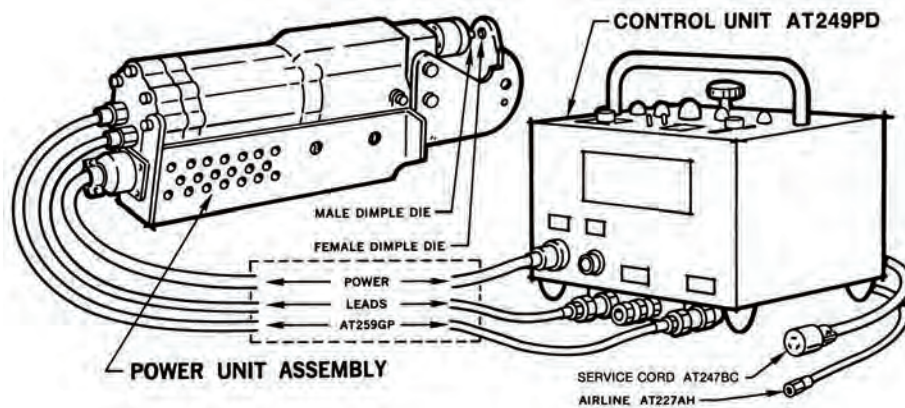

PORTABLE HOT DIMPLING

- Dimple Dies are made from heat-treated tool steel, ground, and polished
- Shank diameter is 3/16" and features a spring clip to keep dies in place during use
- For AN426 rivets



AT1206A-6-R

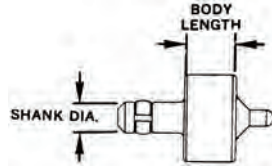

AT1207A-5-R

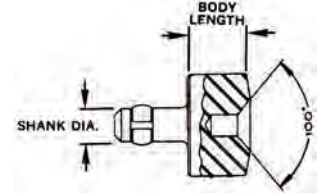

Rivet Size		3/32"			1/8"		
Type		Male	Female	Male & Female	Male	Female	Male & Female
Body Length	1/4"	AT1206A-3-P	AT1207A-3-P	AT1207206A3P	AT1206A-4-P	AT1207A-4-P	AT1207206A4P
	3/8"	AT1206A-3-R	AT1207A-3-R	AT1207206A3R	AT1206A-4-R	AT1207A-4-R	AT1207206A4R
	1/2"	AT1206A-3-S	AT1207A-3-S	AT1207206A3S	AT1206A-4-S	AT1207A-4-S	AT1207206A4S
	5/8"	AT1206A-3-T	AT1207A-3-T				

Rivet Size		5/32"			3/16"			1/4"	
Type		Male	Female	Male & Female	Male	Female	Male & Female	Male	Female
Body Length	1/4"	AT1206A-5-P	AT1207A-5-P	AT1207206A5P	AT1206A-6-P	AT1207A-6-P	AT1207206A6P	AT1206A-8-P	AT1207A-8-P
	3/8"	AT1206A-5-R	AT1207A-5-R	AT1207206A5R	AT1206A-6-R	AT1207A-6-R	AT1207206A6R	AT1206A-8-R	AT1207A-8-R
	1/2"	AT1206A-5-S	AT1207A-5-S		AT1206A-6-S	AT1207A-6-S	AT1207206A6S		
	5/8"								

Included in 24 Piece Kit

DIMPLE DIE KIT

AT1206A-24PC

- Kit contains 24 male and female dimple dies for use with hand and stationary rivet squeezers
- Dies contained in a sturdy, tool-control style box



DIMPLE DIES AND DIMPLING EQUIPMENT

PORTABLE HOT DIMPLING SQUEEZER



USED WITH ATI249PD THERMOMATIC DIMPLING CONTROL UNIT

This squeezer is specifically designed for use where stationary dimpling operation is impractical and sometimes impossible. The unit is capable of working all material gauges up to and including .091". Male and female dies are independently heated by 650-watt heaters and operated from a supply of 110 volts, 60 cycle. This high wattage output produces a short heat-up and recovery time. The male (die) heater is adjustable for maximum squeeze for all material gauges. Also incorporated in this design is a cooling feature which affords ease of handling, and reduces power loss due to heat interference.



Part Number	Throat Depth
ATI259G	2"
ATI259H	4"
ATI259J	6"

Note: Power leads, air lines and control unit sold separately

PORTABLE HOT DIMPLING EQUIPMENT

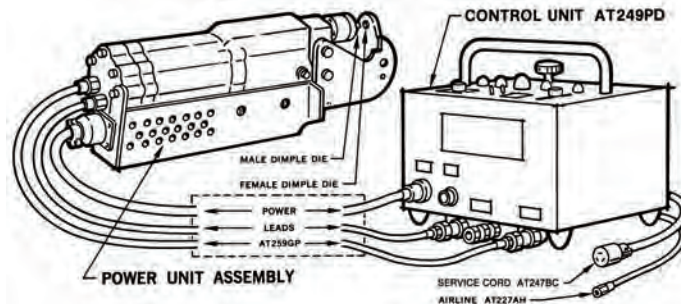

ATI247BC

Used to supply the 110-Volt power from the service outlet to the Thermomatic Dimpling Control Unit. This neoprene-covered cord is 20 feet long, has three #12 leads and uses a "Hubble #7555" female plug which is adaptable to all ATI-Brand Dimpling Control Units. Male plug not furnished because of the different service outlets used in various plants.



ATI227AH

A 20-foot oil-resistant neoprene hose used with all ATI-Brand Dimpling Equipment. Standard quick-release male and female couplings are an integral part of this air hose.



ATI259GP

A 12-foot power lead with male and female receptacles to connect to the ATI249PD Control Panel and ATI259 Portable Squeezers. Protective neoprene casing is held in place by an AN nut and ferrule. The unit is designed to withstand rough handling without damage to the enclosed cable or thermocouple leads.

THERMOMATIC DIMPLING CONTROL UNIT

With Solid State Temperature Controls and Digital Display

ATI249PD

The ATI249PD Thermomatic Dimpling Control Unit is a small, compact unit designed to regulate and automatically control dimple die temperatures, prepressure, dwell time and final forming pressure for ATI-Brand Dimpling Equipment. It will operate on single or dual heater tools and contains a solid state temperature control for 0° to 800° F. The high operating efficiency of the unit eliminates waiting for tools to replace heat dissipated into the dimpled sheet. The "Under Temperature Control" makes the equipment inoperative if the die temperature drops below range, preventing the possibility of under-temperature dimpling. A Thermocouple Break Protector prevents the tools from overheating in the event of a thermocouple wire failure. The proper control of pressure, time and temperature are necessary factors in a good, hot dimpling operation. The Thermomatic Unit will control these factors from simple predetermined settings, resulting in dimples of the highest quality.



MALE DIMPLE DIES

For use with ATI256SS Stationary Dimpling Machine or ATI259 Portable Dimpling Squeezer.

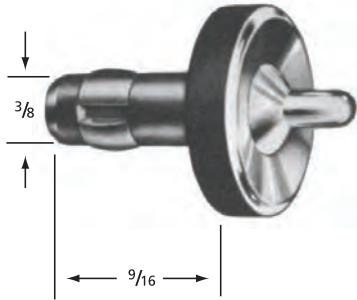

Fastener	Part Number	Size	Pilot Drill Size
AN426 RIVET	ATI252DA-3	3/32"	#40
	ATI252DA-4	1/8"	#30
	ATI252DA-5	5/32"	#21
	ATI252DA-6	3/16"	#10
	ATI252DA-8	1/4"	1/4"
	ATI252DA10	5/16"	5/16"
AN509 SCREW	ATI252DB-8	#8	#36
	ATI252DB-10	#10	#30
	ATI252DB-12	1/4"	#19
HI-SHEAR RIVET	ATI252DC-3	3/16"	#30
	ATI252DC-4	1/4"	#19
	ATI252DC-5	5/16"	#5
DZUS STUD	ATI252DD-8	FA5	5/16"
DZUS STUD	ATI252DD-9	FA6-1/2"	7/16"
DZUS SPRING	ATI252DD-10	FA5	5/16"
DZUS SPRING	ATI252DD-12	FA6-1/2"	7/16"
AIRLOC	ATI252DD-2	7/32"	7/32"
	ATI252DD-5	5/16"	5/16"
	ATI252DD-7	3/8"	3/8"

FEMALE DIMPLE DIES



For use with ATI256SS Stationary Dimpling Machine.

Fastener	Part Number	Size	Pilot Drill Size
AN426 RIVET	ATI254DA-3	3/32"	#40
	ATI254DA-4	1/8"	#30
	ATI254DA-5	5/32"	#21
	ATI254DA-6	3/16"	#10
	ATI254DA-8	1/4"	1/4"
	ATI254DA10	5/16"	5/16"
AN509 SCREW	ATI254DB-8	#8	#36
	ATI254DB-10	#10	#30
	ATI254DB-12	1/4"	#19
HI-SHEAR RIVET	ATI254DC-3	3/16"	#30
	ATI254DC-4	1/4"	#19
	ATI254DC-5	5/16"	#5
DZUS STUD	ATI254DD-8	FA5	5/16"
DZUS STUD	ATI254DD-9	FA6-1/2"	7/16"
DZUS SPRING	ATI254DD-10	FA5	5/16"
DZUS SPRING	ATI254DD-12	FA6-1/2"	7/16"
AIRLOC	ATI254DD-2	7/32"	7/32"
	ATI254DD-5	5/16"	5/16"
	ATI254DD-7	3/8"	3/8"

For use with ATI259 Portable Dimpling Machine

Fastener	Part Number	Size	Pilot Drill Size
AN426 RIVET	ATI251DA-3	3/32"	#40
	ATI251DA-4	1/8"	#30
	ATI251DA-5	5/32"	#21
	ATI251DA6	3/16"	#10
	ATI251DA8	1/4"	1/4"
	ATI251DA10	5/16"	5/16"
AN509 SCREW	ATI251DB-8	#8	#36
	ATI251DB-10	#10	#30
	ATI251DB-12	1/4"	#19
HI-SHEAR RIVET	ATI251DC-3	3/16"	#30
	ATI251DC-4	1/4"	#19
	ATI251DC-5	5/16"	#5
DZUS STUD	ATI251DD-8	FA5	5/16"
DZUS STUD	ATI251DD-9	FA6-1/2"	7/16"
DZUS SPRING	ATI251DD-10	FA5	5/16"
DZUS SPRING	ATI251DD-12	FA6-1/2"	7/16"
AIRLOC	ATI251DD-2	7/32"	7/32"
	ATI251DD-5	5/16"	5/16"
	ATI251DD-7	3/8"	3/8"



SAFETY PRECAUTION: Read and follow all safety and operating instructions.
WARNING: Face & eye protection must be worn while operating power tools, per ANSI B186.1

DRILLS AND ATTACHMENTS

Research and practical application in restricted-area drilling have enabled ATI to design and manufacture the power transmission tools shown in this section. These units have been engineered to perform a multitude of close-quarter drilling operations at low-cost, with emphasis on durability and trouble-free service.



Included are 45°, 90°, 180°, and 360° adjustable models. These angle drills are available in direct drive and flexible drive, with integral chuck or a variety of threaded spindle sizes. To guarantee excellent service, the precision-ground drive shafts and spindles are made of heat-treated tool steel, and revolve on ball and oilite-type bearings.



- Used for drilling holes in tight access areas
- Heavy duty gears and bearings
- 1/4" shank for easy connection to drill motors
- Rated for 4500 RPM

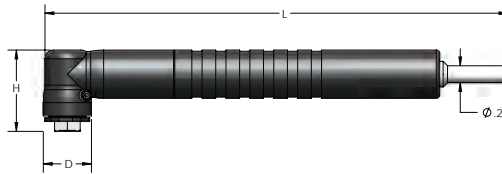

Part Number	Type	Duty	Output Spindle	Drill Capacity	Length	Head Height	Head Diameter
ATI300B	90° Direct Drive	STANDARD	1/4"-28	5/16	6.00	1.625	0.813
ATI301B	45° Direct Drive	STANDARD	1/4"-28	5/16	6.69	1.000	0.813
ATI302B	90° Flex Drive	STANDARD	1/4"-28	5/16	30.00	1.625	0.813
ATI303B	45° Flex Drive	STANDARD	1/4"-28	5/16	30.00	1.000	0.813
ATI326A	90° Direct Drive	LIGHT	10-32	3/16	6.88	0.813	0.500
ATI327A18	90° Flex Drive	LIGHT	10-32	3/16	18.00	0.813	0.500
ATI327A-24	90° Flex Drive	LIGHT	10-32	3/16	24.00	0.813	0.500
ATI326B	90° Direct Drive	LIGHT	1/4"-28	3/16	6.88	0.813	0.500
ATI327B-12	90° Flex Drive	LIGHT	1/4"-28	3/16	12.00	0.813	0.500
ATI327B18	90° Flex Drive	LIGHT	1/4"-28	3/16	18.00	0.813	0.500
ATI327B-24	90° Flex Drive	LIGHT	1/4"-28	3/16	24.00	0.813	0.500
ATI336A	90° Direct Drive	HEAVY	CHUCK	1/4	6.25	1.438	1.000
ATI338A	90° Flex Drive	HEAVY	CHUCK	1/4	30.00	1.438	1.000
ATI336B	90° Direct Drive	HEAVY	1/4"-28	1/4	6.25	1.438	1.000
ATI338B	90° Flex Drive	HEAVY	1/4"-28	1/4	30.00	1.438	1.000
ATI337A	360° Direct Drive	HEAVY	CHUCK	1/4	6.00	1.438	1.000
ATI339A	360° Flex Drive	HEAVY	CHUCK	1/4	30.00	1.438	1.000
ATI337B	360° Direct Drive	HEAVY	1/4"-28	1/4	6.00	1.438	1.000
ATI339B	360° Flex Drive	HEAVY	1/4"-28	1/4	30.00	1.438	1.000



OFFSET DRILL ATTACHMENTS

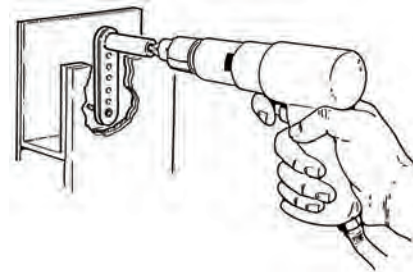
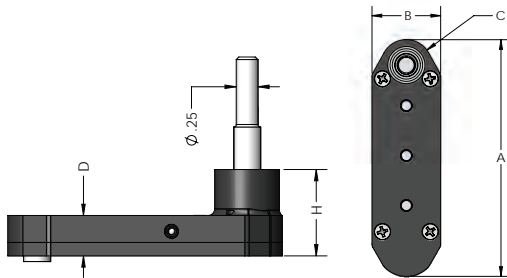

- Offset drive enables drilling in tight access areas
- 1/4" round shank

Part Number	Type	Speed	Spindle	Height (H)	Length (A)	Width (B)	Thickness (D)	Radius C
ATI1313A	Straight Offset	6000	10-32	4.31	4.35	0.875	0.290	0.42
ATI1313B	Straight Offset	6000	1/4"-28	4.31	4.35	0.875	0.290	0.42
ATI1313LA	30° Left Hand Offset	6000	10-32	4.31	4.00	0.875	0.290	0.42
ATI1313LB	30° Left Hand Offset	6000	1/4"-28	4.31	4.00	0.875	0.290	0.42
ATI1313RA	30° Right Hand Offset	6000	10-32	4.31	4.00	0.875	0.290	0.42
ATI1313RB	30° Right Hand Offset	6000	1/4"-28	4.31	4.00	0.875	0.290	0.42
ATI1331A	Straight Offset	6000	10-32	4.38	4.19	0.921	0.438	0.44
ATI1331B	Straight Offset	6000	1/4"-28	4.38	4.19	0.921	0.438	0.44
ATI1332A	Straight Offset	4200	10-32	1.50	3.17	0.920	0.370	0.34
ATI1332B	Straight Offset	4200	1/4"-28	1.50	3.17	0.920	0.370	0.34
ATI1332SC	Straight Offset	4200	1/4"-28	1.50	3.12	0.920	0.320	0.31
ATI1333B	Straight Offset, Reversed	4200	1/4"-28	1.50	3.18	0.960	0.500	0.32



SAFETY PRECAUTION: Read and follow all safety and operating instructions.
WARNING: Face & eye protection must be worn while operating power tools, per ANSI B186.1

DRILL ATTACHMENTS AND DRILLING ACCESSORIES

DRILL GUIDE HOUSINGS



- Maintains tool perpendicular to flat or curved surfaces
- Used with drills, taps or reamers
- Case-hardened bushings are interchangeable in housings
- Housings provide ample relief for chips under the bushing
- Guide assemblies consist of housing with bushing installed
- Threaded interface allows interchangeability of bushings and housings

ATI589AA



STANDARD SLIP RENEWABLE
DRILL BUSHING
*Not available
from ATI

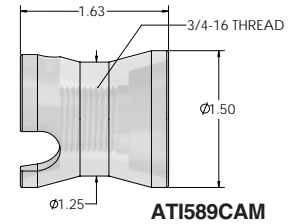
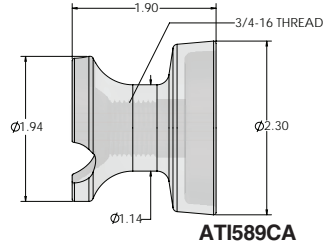
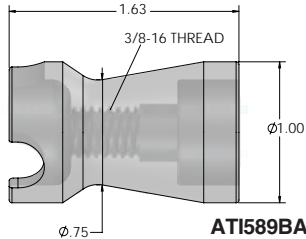
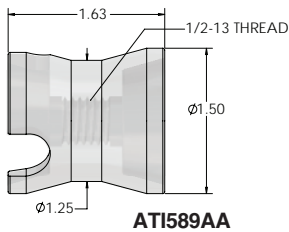

DRILL GUIDE HOUSINGS

Housing Part Number	Description	Bushing Reference
ATI589AA	THREADED DRILL GUIDE HOUSING DRILL SIZES #40 (.098) THRU 5/16" (.3125)	ATI589AB-series 1/2"-13
ATI589BA	THREADED DRILL GUIDE HOUSING DRILL SIZES #40 (.098) THRU 1/4"	ATI58924T-series 3/8"-16
ATI589CA	THREADED DRILL GUIDE HOUSING LARGER DIAMETER FOR EASE IN BUSHING EXCHANGE DRILL SIZES 1/4" (.250) THRU 9/16" (.5625)	ATI589CB-series 3/4"-16
ATI589CAM	THREADED DRILL GUIDE HOUSING DRILL SIZES 1/4" (.250) THRU 9/16" (.5625)	ATI589CB-series 3/4"-16
ATI589DA	FLANGE LOCK DRILL GUIDE HOUSING DRILL SIZES #80 (.0135) THRU #10 (.1935)	*SLIP RENEWABLE 5/16" OD X 3/4" LONG
ATI589EA	FLANGE LOCK DRILL GUIDE HOUSING DRILL SIZES #28 (.1405) THRU 11/32" (.3438)	*SLIP RENEWABLE 1/2" OD X 3/4" LONG

DRILL BUSHING ASSEMBLY KIT

ATI590DBK

These unique hand-held guides keep drills and taps perpendicular to the skin surface. The interchangeable bushings are hardened to provide maximum wear and extended life. The kit consists of three plastic housings and nine bushings.

Kit includes:

3	ATI589AA	1	ATI589AB1875
1	ATI589AB098	1	ATI589AB1935
1	ATI589AB1285	1	ATI589AB2187
1	ATI589AB1562	1	ATI589AB250
1	ATI589AB159	1	ATI589AB-257



Drill Guide Assemblies Part Number	Drill Bushing Part Number	Drill Size	Bushing Size
ATI589A-3T098	ATI58924T098	#40	3/8"-16
ATI589A-3T125	ATI58924T125	1/8"	3/8"-16
ATI589A-3T128	ATI58924T128	#30	3/8"-16
ATI589A-3T156	ATI58924T156	5/32"	3/8"-16
ATI589A-3T159	ATI58924T159	#21	3/8"-16
ATI589A-3T161	ATI58924T161	#20	3/8"-16
ATI589A-3T177	ATI58924T177	#16	3/8"-16
ATI589A-3T187	ATI58924T187	3/16"	3/8"-16
ATI589A-3T193	ATI58924T193	#10	3/8"-16
ATI589A-3T234	ATI58924T234	15/64"	3/8"-16
ATI589A-3T250	ATI58924T250	1/4 or E	3/8"-16

*Special drill bushing sizes available upon request



Drill Guide Assembly

Drill Guide Assemblies Part Number	Drill Bushing Part Number	Drill Size	Bushing Size
ATI589A-093	ATI589AB093	3/32	1/2"-13
ATI589A-098	ATI589AB098	#40	1/2"-13
ATI589A-125	ATI589AB125	1/8	1/2"-13
ATI589A-1285	ATI589AB1285	#30	1/2"-13
ATI589A-1562	ATI589AB1562	5/32	1/2"-13
ATI589A-159	ATI589AB159	#21	1/2"-13
ATI589A161	ATI589AB-161	#20	1/2"-13
ATI589A166	ATI589AB-166	#19	1/2"-13
ATI589A173	ATI589AB-173	#17	1/2"-13
ATI589A177	ATI589AB-177	#16	1/2"-13
ATI589A185	ATI589AB1850	#13	1/2"-13
ATI589A-1875	ATI589AB1875	3/16	1/2"-13
ATI589A189	ATI589AB1890	#12	1/2"-13
ATI589A191	ATI589AB191	#11	1/2"-13
ATI589A-1935	ATI589AB1935	#10	1/2"-13
ATI589A-199	ATI589AB-199	#8	1/2"-13
ATI589A2187	ATI589AB2187	7/32	1/2"-13
ATI589A2344	ATI589AB2344	15/64	1/2"-13
ATI589A250	ATI589AB250	1/4 or E	1/2"-13
ATI589A257	ATI589AB-257	F	1/2"-13

*Special drill bushing sizes available upon request



Drill Bushing

Drill Guide Assemblies Part Number	Drill Bushing Part Number	Drill Size	Bushing Size
ATI589C-2812	ATI589CB2812	9/32	3/4"-16
ATI589C.3125	ATI589CB3125	5/16	3/4"-16
ATI589C-3437	ATI589CB3437	11/32	3/4"-16
ATI589C-375	ATI589CB375	3/8	3/4"-16
ATI589C-4375	ATI589CB4375	7/16	3/4"-16
ATI589C-.500	ATI589CB500	1/2	3/4"-16

*Special drill bushing sizes available upon request



SAFETY PRECAUTION: Read and follow all safety and operating instructions.
WARNING: Face & eye protection must be worn while operating power tools, per ANSI B186.1

DRILL ATTACHMENTS AND DRILLING ACCESSORIES

STRAP DUPLICATORS



FEATURES:

- Provides an accurate method for duplicating hidden holes in overlapping sheets
- Standard pilots are used when sheets can be pried apart. Inverted pilots are used when sheets cannot be separated. Spring loaded center punch allows for marking in limited access for drilling later
- Position pilot in hole to be duplicated then drill through bushing. Back side of pilot is relieved to allow drill to pass through first sheet only
- Straps are spring steel. Bushings, pilots and center punch are hardened drill rod assuring accurate hole duplication. Tools are identified with part number and drill size
- Working length is shown, maximum distance from edge of sheet to hole. Back side of strap is beveled to aid in prying sheets apart



AT1532-61



AT1500-52

6-1/4" Length Part Number	13-1/4" Length Part Number	Type	Drill Size
AT1532-61	AT1532C-61	Bushing, Standard Pilot	#40
AT1532-62	AT1532C-62	Bushing, Standard Pilot	#30
AT1532-63	AT1532C-63	Bushing, Standard Pilot	#21
AT1532-64	AT1532C-64	Bushing, Standard Pilot	#19
AT1532-65	AT1532C-65	Bushing, Standard Pilot	#10
AT1532-66	AT1532C-66	Bushing, Standard Pilot	#5
AT1532-67	AT1532C-67	Bushing, Standard Pilot	F
AT1532-68	AT1532C-68	Bushing, Standard Pilot	1/4"

*Special bushing and pilot sizes available upon request

6-1/4" Length Part Number	13-1/4" Length Part Number	Type	Drill Size
AT1500-51	AT1500C-51	Spring Loaded Center Punch	#40
AT1500-52	AT1500C-52	Spring Loaded Center Punch	#30
AT1500-53	AT1500C-53	Spring Loaded Center Punch	#21
AT1500-54	AT1500C-54	Spring Loaded Center Punch	#19
AT1500-55	AT1500C-55	Spring Loaded Center Punch	#10
AT1500-56	AT1500C-56	Spring Loaded Center Punch	#5
AT1500-57	AT1500C-57	Spring Loaded Center Punch	F
AT1500-58	AT1500C-58	Spring Loaded Center Punch	1/4"

*Special bushing and pilot sizes available upon request



AT1532A-61

6-1/4" Length Part Number	13-1/4" Length Part Number	Type	Drill Size
AT1532A-61	AT1532D-61	Bushing, Inverted Pilot	#40
AT1532A-62	AT1532D-62	Bushing, Inverted Pilot	#30
AT1532A-63	AT1532D-63	Bushing, Inverted Pilot	#21
AT1532A-64	AT1532D-64	Bushing, Inverted Pilot	#19
AT1532A-65	AT1532D-65	Bushing, Inverted Pilot	#10
AT1532A-66	AT1532D-66	Bushing, Inverted Pilot	#5
AT1532A-67	AT1532D-67	Bushing, Inverted Pilot	F
AT1532A-68	AT1532D-68	Bushing, Inverted Pilot	1/4"

*Special bushing and pilot sizes available upon request

STRAP DUPLICATORS SETS

AT1532A/SET	10 PIECE SET STANDARD & INVERTED PILOT	Includes Items in Blue
-------------	--	------------------------

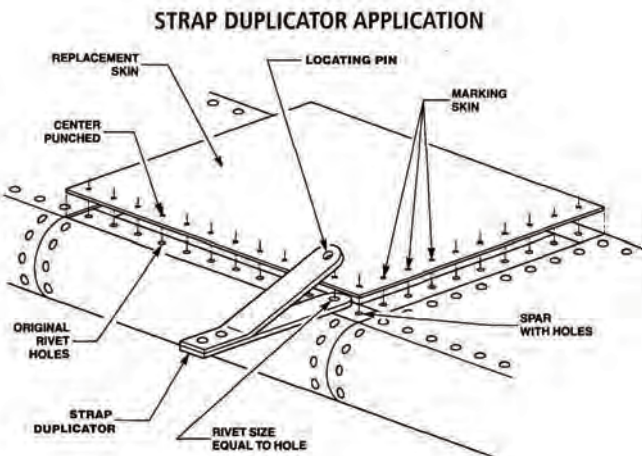

THREADED SHANK 3-JAW CHUCK
ATI339EC

- Drill bit capacity from 1/16" to 1/4"
- Allows use of standard straight shank drills in tools with threaded spindles
- Internal jaws are inverted for maximum chucking torque
- 1/4"-28 threaded shank



ATI339EC

THREADED SHANK DRILL ADAPTORS

- Enables use of straight shank drill bits with threaded output angle drill attachments
- Retains drill bit with set screw
- 1/4"-28 threaded shank



ATI503-40



ATI503-72

Part Number	Drill Size
ATI503-40	#40
ATI503-30	#30
ATI503-21	#21
ATI503-20	#20
ATI503-11	#11
ATI503-10	#10
ATI503-3	#3
ATI503-66	1/8
ATI503-70	3/16
ATI503-72	1/4
ATI503-73	5/16
ATI503-74	3/8
ATI503-77	F
ATI503-78	N

THREADED SHANK DRILL COLLETS

- Enables use of straight shank drill bits with threaded output angle drill attachments
- 1/4"-28 threaded shank



ATI503C-1/8

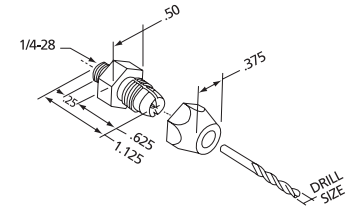

Part Number	Drill Size
ATI503C-3/32	3/32
ATI503C-40	#40
ATI503C-1/8	1/8
ATI503C-30	#30
ATI503C-5/32	5/32
ATI503C-21	#21
ATI503C-20	#20
ATI503C-19	#19
ATI503C-16	#16
ATI503C-3/16	3/16
ATI503C-12	#12
ATI503C-11	#11
ATI503C-10	#10
ATI503C-7/32	7/32
ATI503C-1/4	1/4
ATI503C-F	F

QUICK-CHANGE DRILL COLLET

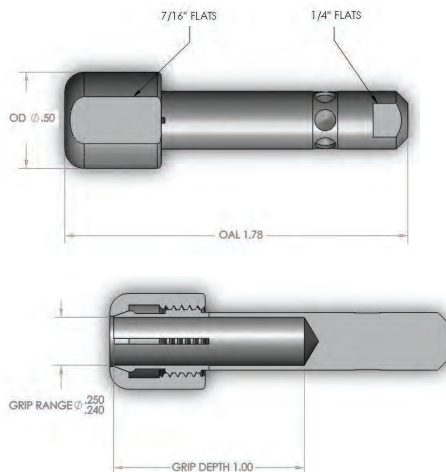

Part Number	Description
ATI504C-1/4	Colletting Adaptor, Two-Piece, Quick-change shank, 1/4"

DRILL STOPS

- Controls hole depth and prevents chuck jaws from contacting drilled surface
- Unit locks onto drill bit with a set screw



ATI570-30

Part Number	Drill Size	Color
ATI570-50	#50	Black
ATI570-40	#40	Zinc
ATI570-30	#30	Copper
ATI570-28	#28	Zinc
ATI570-27	#27	Zinc
ATI570-21	#21	Black
ATI570-20	#20	Zinc
ATI570-16	#16	Black
ATI570-12	#12	Brass
ATI570-11	#11	Brass
ATI570-10	#10	Brass
ATI570-13/64	13/64	Brass
ATI5707/32	7/32	Zinc
ATI570-1/4	1/4	Copper
ATI570-5/16	5/16	Copper



SAFETY PRECAUTION: Read and follow all safety and operating instructions.
WARNING: Face & eye protection must be worn while operating power tools, per ANSI B186.1

DRILL ATTACHMENTS AND DRILLING ACCESSORIES

THREADED DRILLS, DEBURRING TOOLS AND CHIP CHASERS



THREADED SHANK DRILL BITS

- MADE FROM HSS
- 135° Split Point
- 1/4"-28 threaded shank

Part Number	Drill Size	Length	Type	Part Number	Drill Size	Length	Type
ATIHSSST3/32	3/32	0.50	STUB	ATIHSSL5/32	5/32	2.13	LONG
ATIHSSST40	#40	0.50	STUB	ATIHSSST21	#21	0.56	STUB
ATIHSSSH40	#40	1.00	SHORT	ATIHSSST3/16	3/16	0.56	STUB
ATIHSSST1/8	1/8	0.50	STUB	ATIHSSSH3/16	3/16	1.25	SHORT
ATIHSSSH1/8	1/8	1.00	SHORT	ATIHSSL3/16	3/16	2.13	LONG
ATIHSSL1/8	1/8	2.13	LONG	ATIHSSST10	#10	0.56	LONG
ATIHSSST30	#30	0.56	STUB	ATIHSSH10	#10	1.25	SHORT
ATIHSSH30	#30	1.25	SHORT	ATIHSSST1/4	1/4	0.63	STUB
ATIHSSL30	#30	2.13	LONG	ATIHSSSH1/4	1/4	1.25	SHORT
ATIHSSST5/32	5/32	0.56	STUB	ATIHSSL1/4	1/4	2.13	LONG
ATIHSSSH5/32	5/32	1.25	SHORT				

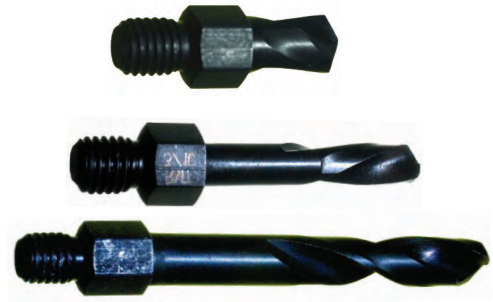

SPEED DRIVER, DEBURRING TOOLS AND CUTTERS

'Speed Driver' an ATI original, with swivel handle and unique offset shaft allows for rapid, uniform and safe deburring of drilled holes.

Part Number	Description
ATI521A	SPEED DRIVER, used with ATI521C deburring cutter. Tool has a taper lock spindle and only accepts this cutter
ATI521B	SPEED DRIVER, used with ATI407-4 deburr/countersink cutter. Accepts any 1/4"-28 threaded shank cutters
ATI521C	DEBURRING CUTTER, 100-degree cutting angle, 3-flute, 3/8" body, 7/32 shank diameter
ATI407-4	COUNTERSINK CUTTER, 100-degree cutting angle, 3-flute, 3/8" body, 1/4"-28 threaded shank. Can be used in any drill attachment that accepts 1/4"-28 threaded shank cutters



CARBIDE DEBURRING BLADE

ATI437C SERIES

Used in conjunction with squaring and deburring heads, these blades perform on hydraulic tubing ends. Available in sets of 3 or individually. A set includes one outside, one inside, and one squaring blade.

3 Piece Kit	Square Blade	Inside Blade	Outside Blade
ATI437C	ATI437C-1	ATI437C-2	ATI437C-3

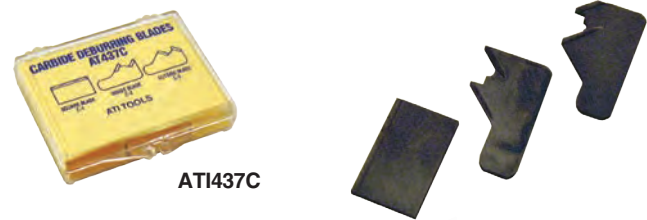

CHIP CHASERS

Designed to remove chips that accumulate between sheet stock after drilling rivet holes. Handles are cast aluminum and the blades are made from clock spring steel.

CHIP CHASERS WITH INTERCHANGEABLE BLADES

Chip Chaser Assembly Part Number	Chip Chaser Blade Part Number	Blade Length	Hook Style
ATISP200-1	ATISP20002	5-7/8"	Pointed
ATISP200-2	ATISP20003	5-7/8"	Blunt
ATISP200-3	ATISP20004	2-3/4"	Pointed
ATISP200-4	ATISP20005	2-3/4"	Blunt
ATISP200	Chip Chaser Handle		

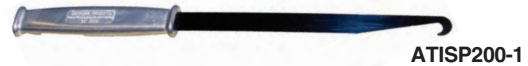

CHIP CHASERS WITH MOLDED HANDLES

Chip Chaser Part Number	Blade Length	Hook Style
ATI511	2-3/4"	Pointed
ATI512	5-7/8"	Pointed



EDGE BREAKERS

Quickly removes burrs & sharp edges from sheet stock.

Part Number	Description
ATI514	Hardened tip, safety shield and plastic handle works well on aluminum sheet stock



BURNISHING TOOL - ATI515

Designed to remove blemishes in materials. Heat-treated blade is chrome-plated, polished to mirror finish, and 2-3/8" long. Large plastic safety handle insures comfortable grip.

Part Number	Description
ATI515	Burnishing Tool, Hard chrome plated, 2-3/8" blade length, plastic handle



DUPLICATING PUNCHES

- Accurately duplicate hole location from one sheet to another.
- Heat-treated, the locating diameter and punch are ground to insure absolute concentricity and held to close tolerances

Part Number	D	L
ATI507-1	3/32	1/4
ATI507-2	#40	1/4
ATI507-3	1/8	3/8
ATI507-4	#30	3/8
ATI507-5	5/32	1/2
ATI507-6	#19	1/2
ATI507-7	3/16	1/2
ATI507-8	#10	1/2
ATI507-9	7/32	1/2
ATI507-10	1/4	1/2
ATI507-11	5/16	1/2
ATI507-12	3/8	1/2
ATI507-13	7/16	1/2
ATI507-14	1/2	1/2

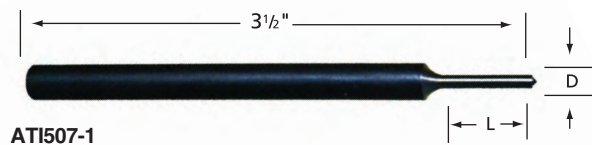

DUPLICATING PUNCH KIT

ATI507KT

Kit contains fourteen 3-1/2" OAL punches, sizes 3/32", #40, 1/8", #30, 5/32", #19, 3/16", #10, 7/32", 1/4", 5/16", 3/8", 7/16", and 1/2".



DRILL ATTACHMENTS AND DRILLING ACCESSORIES

NUT PLATE DRILL JIGS



- Used for accurate drilling of rivet holes for nut plate fasteners
- Flexible handle provides clearance for hand during use
- Hardened steel head for durability

ONE LUG — SINGLE WING STANDARD (SWS)

Part Number	Type	"A" Spacing	"C" Pilot Diameter	"D" Drill Size
ATI518G	SWS	.344	.139	#40
ATI518H	SWS	.344	.164	#40
ATI518RL	SWS	.344	.165	#40
ATI518RC	SWS	.344	.168	#40
ATI518RM	SWS	.344	.188	#40
ATI518J	SWS	.344	.191	#40
ATI518RD	SWS	.344	.192	#40
ATI518L	SWS	.344	.213	#40
ATI518RU	SWS	.344	.227	#40
ATI518K	SWS	.344	.248	#40
ATI518RE	SWS	.344	.256	#40
ATI518LF	SWS	.344	.281	#40
ATI518RW	SWS	.344	.311	#40
ATI518RO	SWS	.500	.248	#40
ATI518RF	SWS	.500	.256	#40
ATI518RX	SWS	.500	.311	#40
ATI518YF	SWS	.500	.343	#40
ATI518RP	SWS	.500	.311	#30
ATI518RG	SWS	.500	.315	#30
ATI518FH	SWS	.500	.372	#30
ATI518RH	SWS	.500	.373	#30
ATI518RJ	SWS	.562	.435	#30
ATI518RB	SWS	.344	.143	#40



ATI518J

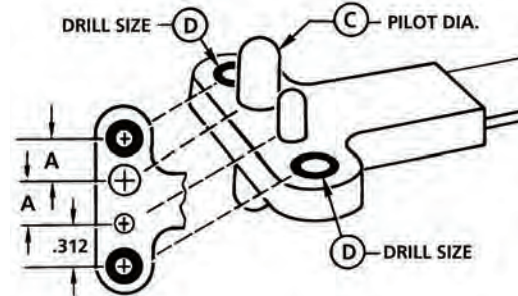

»» ORDER SPECIAL ONE-LUG, SINGLE-WING STANDARD, DRILL JIG'S AS FOLLOWS:

ATI518SWS-.XXX-.XXXX-.XX

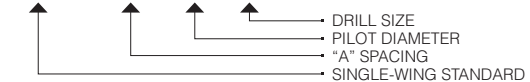

*VALUES MAY BE EXPRESSED IN METRIC

ONE LUG — SINGLE WING MINIATURE (SWM)

Part Number	Type	"A" Spacing	"C" Pilot Diameter	"D" Drill Size
ATI518NASBA2	SWM	.125	.086	#51
ATI518NASBA3	SWM	.133	.099	#51
ATI518NASBA4	SWM	.148	.112	#51
ATI518NASBA6	SWM	.171	.139	#51
ATI518PA	SWM	.203	.112	#40
ATI518JA	SWM	.203	.140	#40
ATI518PB	SWM	.218	.139	#40
ATI518JB	SWM	.218	.166	#40
ATI518PC	SWM	.234	.164	#40
ATI518JC	SWM	.234	.193	#40
ATI518PD	SWM	.250	.191	#40
ATI518JD	SWM	.250	.218	#40
ATI518PE	SWM	.281	.248	#40
ATI518JE	SWM	.281	.281	#40
ATI518PF	SWM	.250	.188	#40



ATI518PB

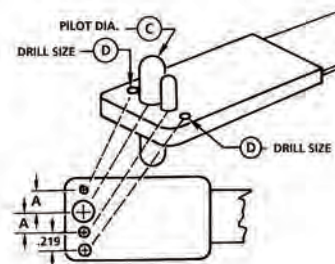

»» ORDER SPECIAL ONE-LUG, SINGLE-WING MINIATURE, DRILL JIG'S AS FOLLOWS:

ATI518SWM-.XXX-.XXXX-.XX



*VALUES MAY BE EXPRESSED IN METRIC



SAFETY PRECAUTION: Read and follow all safety and operating instructions.

WARNING: Face & eye protection must be worn while operating power tools, per ANSI B186.1

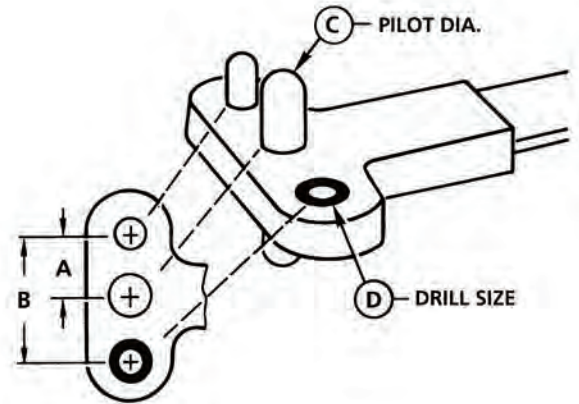

TWO LUG — DOUBLE WING STANDARD (DWS)

Part Number	Type	"A" Spacing	"B" Spacing	"C" Pilot Diameter	"D" Drill Size
AT1518A	DWS	.344	.688	.139	#40
AT1518B	DWS	.344	.688	.164	#40
AT1518KK	DWS	.344	.688	.165	#40
AT1518KC	DWS	.344	.688	.168	#40
AT1518KL	DWS	.344	.688	.188	#40
AT1518C	DWS	.344	.688	.191	#40
AT1518KD	DWS	.344	.688	.192	#40
AT1518KT	DWS	.344	.688	.227	#40
AT1518KU	DWS	.344	.688	.256	#40
AT1518BF	DWS	.344	.688	.281	#40
AT1518HL	DWS	.344	.688	.290	#40
AT1518GM	DWS	.344	.688	.312	#40
AT1518HE	DWS	.3125	.625	.187	#40
AT1518HM	DWS	.3125	.625	.218	#40
AT1518HO	DWS	.375	.750	.248	#40
AT1518HP	DWS	.375	.750	.281	#40
AT1518HH	DWS	.375	.750	.372	#40
AT1518M	DWS	.375	.750	.438	#40
AT1518HN	DWS	.375	.750	.467	#40
AT1518GT	DWS	.4375	.875	.373	#40
AT1518HX	DWS	.450	.900	.372	#40
AT1518D	DWS	.500	1.000	.248	#40
AT1518KE	DWS	.500	1.000	.256	#40
AT1518GR	DWS	.500	1.000	.271	#40
AT1518GS	DWS	.500	1.000	.296	#40
AT1518KV	DWS	.500	1.000	.311	#40
AT1518DF	DWS	.500	1.000	.343	#40
AT1518GG	DWS	.500	1.000	.656	#40
AT1518GL	DWS	.344	.688	.218	#40
AT1518KA	DWS	.344	.688	.119	#40
AT1518KB	DWS	.344	.688	.143	#40
AT1518HF	DWS	.500	1.000	.191	#30
AT1518HJ	DWS	.500	1.000	.248	#30
AT1518KN	DWS	.500	1.000	.311	#30
AT1518E	DWS	.500	1.000	.312	#30
AT1518KF	DWS	.500	1.000	.315	#30
AT1518F	DWS	.500	1.000	.372	#30
AT1518KG	DWS	.500	1.000	.373	#30
AT1518GD	DWS	.500	1.000	.375	#30
AT1518HG	DWS	.500	1.000	.389	#30
AT1518HD	DWS	.500	1.000	.500	#30

»» ORDER SPECIAL TWO-LUG, DOUBLE-WING STANDARD, DRILL JIG'S AS FOLLOWS:

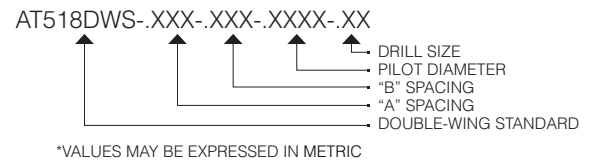

Part Number	Type	"A" Spacing	"B" Spacing	"C" Pilot Diameter	"D" Drill Size
AT1518HS	DWS	.500	1.000	.561	#30
AT1518GB	DWS	.500	1.000	.593	#30
AT1518HT	DWS	.500	1.000	.624	#30
AT1518N	DWS	.500	1.000	.688	#30
AT1518GA	DWS	.500	1.000	.702	#30
AT1518GP	DWS	.562	1.124	.438	#30
AT1518HW	DWS	.592	1.184	.811	#30
AT1518GN	DWS	.595	1.190	.592	#30
AT1518KH	DWS	.625	1.250	.435	#30
AT1518HB	DWS	.687	1.375	.191	#30
AT1518HC	DWS	.687	1.375	.405	#30
AT1518KJ	DWS	.687	1.375	.498	#30
AT1518GE	DWS	.687	1.375	.500	#30
AT1518HK	DWS	.687	1.375	.656	#30
AT1518GC	DWS	.687	1.375	.718	#30
AT1518HA	DWS	.687	1.375	.749	#30
AT1518P	DWS	.687	1.375	.811	#30
AT1518HY	DWS	.700	1.400	.850	#30
AT1518GK	DWS	.500	1.000	.343	#30
AT1518KP	DWS	.500	1.000	.457	#30
AT1518GF	DWS	.375	.750	.437	#40
AT1518GH	DWS	.375	.750	.397	#40
AT1518GJ	DWS	.500	1.000	.281	#40
AT1518SP1171	DWS	.562	1.124	.191	#40
AT1518NASAA5	DWS	.359	.718	.312	#30
AT1518NASA06	DWS	.414	.828	.372	#30



SAFETY PRECAUTION: Read and follow all safety and operating instructions.
WARNING: Face & eye protection must be worn while operating power tools, per ANSI B186.1

DRILL ATTACHMENTS AND DRILLING ACCESSORIES

NUT PLATE DRILL JIGS



TWO LUG — DOUBLE WING MINIATURE (DWM)

Part Number	Type	"A" Spacing	"B" Spacing	"C" Pilot Diameter	"D" Drill Size
ATI518NASAA2	DWM	.125	.250	.086	#51
ATI518NASAA3	DWM	.133	.265	.099	#51
ATI518NASA4	DWM	.148	.296	.112	#51
ATI518NSAA06	DWM	.172	.343	.139	#51
ATI518NA	DWM	.203	.406	.112	#40
ATI518AA	DWM	.203	.406	.140	#40
ATI518BA	DWM	.203	.406	.180	#40
ATI518NB	DWM	.218	.436	.139	#40
ATI518AB	DWM	.219	.437	.166	#40
ATI518BB	DWM	.219	.437	.2055	#40
ATI518NC	DWM	.234	.468	.164	#40
ATI518NG	DWM	.234	.468	.1925	#40
ATI518AC	DWM	.234	.468	.193	#40
ATI518NH	DWM	.234	.468	.227	#40
ATI518BC	DWM	.234	.468	.234	#40
ATI518ND	DWM	.250	.500	.191	#40
ATI518AD	DWM	.250	.500	.218	#40
ATI518BD	DWM	.250	.500	.257	#40
ATI518NE	DWM	.281	.562	.248	#40
ATI518AE	DWM	.281	.562	.281	#40
ATI518BE	DWM	.281	.562	.323	#40
ATI518NF	DWM	.313	.625	.312	#30
ATI518AF	DWM	.313	.625	.343	#30
ATI518ZX	DWM	.539	1.080	.248	#40
ATI518SP1016	DWM	.295	.590	.217	#40
ATI518BG	DWM	.359	.718	.373	#30
ATI518NJ	DWM	.250	.500	.1875	#40

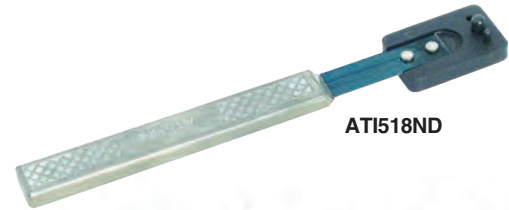

ATI518ND

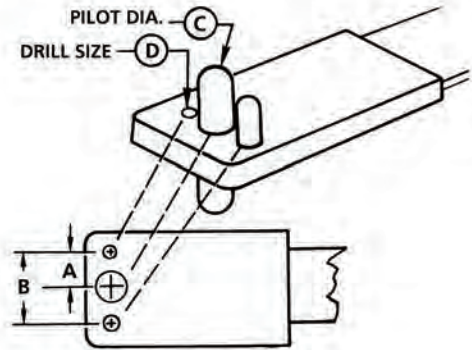

»» ORDER SPECIAL TWO-LUG, DOUBLE-WING MINIATURE, DRILL JIG'S AS FOLLOWS:



CORNER WING STANDARD (CWS)

Part Number	Type	"A" Spacing	"C" Pilot Diameter	"D" Drill Size
ATI518R	CWS	.344	.139	#40
ATI518S	CWS	.344	.164	#40
ATI518MK	CWS	.344	.1645	#40
ATI518MC	CWS	.344	.1675	#40
ATI518ML	CWS	.344	.1875	#40
ATI518T	CWS	.344	.191	#40
ATI518MD	CWS	.344	.192	#40
ATI518MT	CWS	.344	.2265	#40
ATI518MU	CWS	.500	.2555	#40
ATI518U	CWS	.500	.248	#40
ATI518ME	CWS	.500	.2555	#40
ATI518MV	CWS	.500	.3105	#40
ATI518MN	CWS	.500	.311	#30
ATI518V	CWS	.500	.312	#30
ATI518MF	CWS	.500	.3145	#30
ATI518W	CWS	.500	.372	#30
ATI518MP	CWS	.500	.373	#30
ATI518MR	CWS	.562	.435	#30
ATI518X	CWS	.562	.4375	#30
ATI518MB	CWS	.344	.1425	#40
ATI518NASCA5	CWS	.358	.312	#30



ATI518U

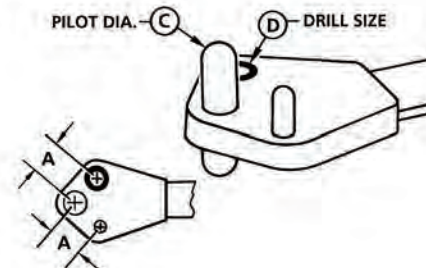

»» ORDER SPECIAL CORNER-WING STANDARD DRILL JIG'S AS FOLLOWS:



SAFETY PRECAUTION: Read and follow all safety and operating instructions.

WARNING: Face & eye protection must be worn while operating power tools, per ANSI B186.1



ATI518SD

CORNER WING MINIATURE (CWM)

Part Number	Type	"A" Spacing	"C" Pilot Diameter	"D" Drill Size
ATI518NSCA02	CWM	.125	.086	#51
ATI518NSCA03	CWM	.138	.099	#51
ATI518NSCA04	CWM	.148	.112	#51
ATI518NSCA06	CWM	.172	.139	#51
ATI518SA	CWM	.203	.112	#40
ATI518UA	CWM	.203	.140	#40
ATI518SB	CWM	.218	.139	#40
ATI518UB	CWM	.218	.166	#40
ATI518SC	CWM	.234	.164	#40
ATI518UC	CWM	.234	.193	#40
ATI518SD	CWM	.250	.191	#40
ATI518UD	CWM	.250	.218	#40
ATI518SE	CWM	.281	.248	#40
ATI518UE	CWM	.281	.281	#40
ATI518SF	CWM	.312	.312	#30
ATI518UF	CWM	.312	.343	#30
ATI518SJ	CWM	.250	.1875	#40

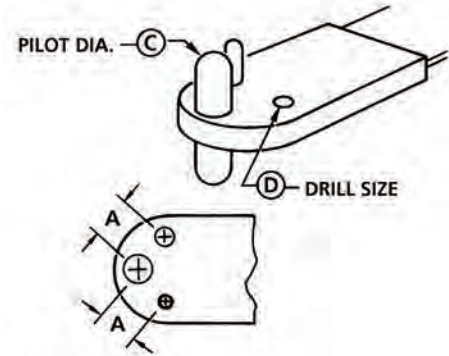

»» ORDER SPECIAL CORNER-WING MINIATURE DRILL JIG'S AS FOLLOWS"

ATI518CWM-.XXXX-.XXXX-.XX



ATI518TA

MINIATURE ANCHORNUIT (SLM)

Part Number	Type	"A" Spacing	"B" Spacing	"C" Pilot Diameter	"D" Drill Size
ATI518NSDA08	SLM	.234	.219	.164	#40
ATI518TA	SLM	.250	.219	.191	#40
ATI518TB	SLM	.281	.219	.248	#40
ATI518TC	SLM	.312	.250	.312	#30
ATI518TD	SLM	.359	.269	.3125	#30
ATI518TE	SLM	.250	.219	.1875	#40
ATI518NASDA5	SLM	.359	.269	.312	#30
ATI518NASDA6	SLM	.414	.269	.372	#30

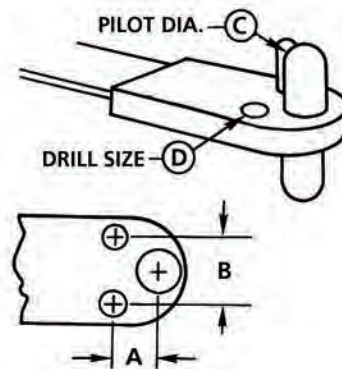

»» ORDER SPECIAL MINIATURE ANCHORNUIT DRILL JIG'S AS FOLLOWS:

ATI518SLM-.XXXX-.XXXX-.XXXX-.XX

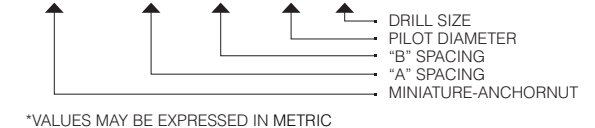

SAFETY PRECAUTION: Read and follow all safety and operating instructions.

WARNING: Face & eye protection must be worn while operating power tools, per ANSI B186.1

DRILL ATTACHMENTS AND DRILLING ACCESSORIES

NUT PLATE CONVERSIONS



SINGLE WING

Nutplate Spec	Style	Part Number
MS21051-06	Single Wing	ATI518G
MS21051-08	Single Wing	ATI518H
MS21051-3	Single Wing	ATI518J
MS21051-4	Single Wing	ATI518K
MS21051-5	Single Wing	ATI518RP
MS21051-6	Single Wing	ATI518RH
MS21052-06	Single Wing	ATI518G
MS21052-08	Single Wing	ATI518H
MS21052-3	Single Wing	ATI518J
MS21052-4	Single Wing	ATI518K
MS21052-5	Single Wing	ATI518RP
MS21052-6	Single Wing	ATI518RH
MS21053-08	Single Wing	ATI518H
MS21053-3	Single Wing	ATI518J
MS21053-4	Single Wing	ATI518RO
MS21053-5	Single Wing	ATI518RP
MS21054-08	Single Wing	ATI518H
MS21054-3	Single Wing	ATI518J
MS21054-4	Single Wing	ATI518RO
MS21054-5	Single Wing	ATI518RP
MS21061-06	Single Wing	ATI518G
MS21061-08	Single Wing	ATI518H
MS21061-3	Single Wing	ATI518J
MS21061-4	Single Wing	ATI518RO
MS21061-5	Single Wing	ATI518RP
MS21061-6	Single Wing	ATI518RH
MS21062-06	Single Wing	ATI518G
MS21062-08	Single Wing	ATI518H
MS21062-3	Single Wing	ATI518J
MS21062-4	Single Wing	ATI518RO
MS21062-5	Single Wing	ATI518RP
MS21062-6	Single Wing	ATI518RH
MS21071-04	Single Wing	ATI518PA
MS21071-06	Single Wing	ATI518PB
MS21071-08	Single Wing	ATI518PC
MS21071-3	Single Wing	ATI518PD
MS21071-4	Single Wing	ATI518PE
MS21072-04	Single Wing	ATI518PA
MS21072-06	Single Wing	ATI518PB
MS21072-08	Single Wing	ATI518PC
MS21072-3	Single Wing	ATI518PD
MS21072-4	Single Wing	ATI518PE
NAS1067-08	Single Wing	ATI518PC
NAS1067-3	Single Wing	ATI518PD
NAS1067-4	Single Wing	ATI518PE
NAS1774-06	Single Wing	ATI518G
NAS1774-08	Single Wing	ATI518H
NAS1774-3	Single Wing	ATI518J
NAS1774-4	Single Wing	ATI518RO
NAS1774-5	Single Wing	ATI518RP

SINGLE WING

Nutplate Spec	Style	Part Number
NAS1774-6	Single Wing	ATI518RH
NAS1792-3	Single Wing	ATI518J
NAS1792-4	Single Wing	ATI518RO
NAS1792-5	Single Wing	ATI518RP
NAS687-06	Single Wing	ATI518G
NAS687-08	Single Wing	ATI518H
NAS687-3	Single Wing	ATI518J
NAS687-4	Single Wing	ATI518RO
NAS687-5	Single Wing	ATI518RP

DOUBLE WING

Nutplate Spec	Style	Part Number
MS21047-06	Double Wing	ATI518A
MS21047-08	Double Wing	ATI518B
MS21047-3	Double Wing	ATI518C
MS21047-4	Double Wing	ATI518D
MS21047-5	Double Wing	ATI518E
MS21047-6	Double Wing	ATI518F
MS21048-06	Double Wing	ATI518A
MS21048-08	Double Wing	ATI518B
MS21048-3	Double Wing	ATI518C
MS21048-4	Double Wing	ATI518D
MS21048-5	Double Wing	ATI518E
MS21048-6	Double Wing	ATI518F
MS21048-7	Double Wing	ATI518GP
MS21049-08	Double Wing	ATI518B
MS21049-3	Double Wing	ATI518C
MS21049-4	Double Wing	ATI518D
MS21049-5	Double Wing	ATI518E
MS21050-08	Double Wing	ATI518B
MS21050-3	Double Wing	ATI518C
MS21050-4	Double Wing	ATI518D
MS21050-5	Double Wing	ATI518E
MS21059-06	Double Wing	ATI518A
MS21059-08	Double Wing	ATI518B
MS21059-3	Double Wing	ATI518C
MS21059-4	Double Wing	ATI518D
MS21059-5	Double Wing	ATI518E
MS21059-6	Double Wing	ATI518F
MS21060-06	Double Wing	ATI518A
MS21060-08	Double Wing	ATI518B
MS21060-3	Double Wing	ATI518C
MS21060-4	Double Wing	ATI518D
MS21060-5	Double Wing	ATI518E
MS21060-6	Double Wing	ATI518F
MS21069-04	Double Wing	ATI518NA
MS21069-06	Double Wing	ATI518NB
MS21069-08	Double Wing	ATI518NC
MS21069-3	Double Wing	ATI518ND
MS21069-4	Double Wing	ATI518NE



DOUBLE WING

Nutplate Spec	Style	Part Number
MS21069-5	Double Wing	ATI518NASAA5
MS21069-6	Double Wing	ATI518NASAA6
MS21070-04	Double Wing	ATI518NA
MS21070-06	Double Wing	ATI518NB
MS21070-08	Double Wing	ATI518NC
MS21070-3	Double Wing	ATI518ND
MS21070-4	Double Wing	ATI518NE
MS21070-5	Double Wing	ATI518NASAA5
MS21075-04	Double Wing	ATI518NA
MS21075-06	Double Wing	ATI518NB
MS21075-08	Double Wing	ATI518NC
MS21075-3	Double Wing	ATI518ND
MS21075-4	Double Wing	ATI518NE
MS21075-5	Double Wing	ATI518NASAA5
MS21076-04	Double Wing	ATI518NA
MS21076-06	Double Wing	ATI518NB
MS21076-08	Double Wing	ATI518NC
MS21076-3	Double Wing	ATI518ND
MS21076-4	Double Wing	ATI518NE
MS21076-5	Double Wing	ATI518NASAA5
NAS1068-04	Double Wing	ATI518NASAA4
NAS1068-06	Double Wing	ATI518NSAA06
NAS1068-08	Double Wing	ATI518NC
NAS1068-3	Double Wing	ATI518ND
NAS1068-4	Double Wing	ATI518NE
NAS1068-5	Double Wing	ATI518NASAA5
NAS1473-08	Double Wing	ATI518B
NAS1473-3	Double Wing	ATI518C
NAS1473-4	Double Wing	ATI518D
NAS1473-5	Double Wing	ATI518E
NAS1474-3	Double Wing	ATI518SP1016
NAS1791-3	Double Wing	ATI518C
NAS1791-4	Double Wing	ATI518D
NAS1791-5	Double Wing	ATI518E
NAS697-02	Double Wing	AT518NASAA02
NAS697-03	Double Wing	AT518NASAA03
NAS697-04	Double Wing	ATI518NASAA4
NAS697-06	Double Wing	ATI518NSAA06
NAS697-08	Double Wing	ATI518NC
NAS697-3	Double Wing	ATI518ND
NAS697-4	Double Wing	ATI518NE
NAS697-5	Double Wing	ATI518NASAA5
NAS697-6	Double Wing	ATI518NASAA6

CORNER

Nutplate Spec	Style	Part Number
MS21055-06	CORNER	ATI518R
MS21055-08	CORNER	ATI518S
MS21055-3	CORNER	ATI518T
MS21055-4	CORNER	ATI518U

CORNER

Nutplate Spec	Style	Part Number
MS21055-5	CORNER	ATI518V
MS21055-6	CORNER	ATI518W
MS21055-7	CORNER	ATI518X
MS21056-06	CORNER	ATI518R
MS21056-08	CORNER	ATI518S
MS21056-3	CORNER	ATI518T
MS21056-4	CORNER	ATI518U
MS21056-5	CORNER	ATI518V
MS21056-6	CORNER	ATI518W
MS21056-7	CORNER	ATI518X
MS21057-08	CORNER	ATI518S
MS21057-3	CORNER	ATI518T
MS21057-4	CORNER	ATI518U
MS21057-5	CORNER	ATI518V
MS21058-08	CORNER	ATI518S
MS21058-3	CORNER	ATI518T
MS21058-4	CORNER	ATI518U
MS21058-5	CORNER	ATI518V
MS21073-02	CORNER	ATI518NSCA02
MS21073-04	CORNER	ATI518SA
MS21073-06	CORNER	ATI518SB
MS21073-08	CORNER	ATI518SC
MS21073-3	CORNER	ATI518SD
MS21073-4	CORNER	ATI518SE
MS21073-5	CORNER	AT518NASCA5
MS21074-02	CORNER	ATI518NSCA02
MS21074-04	CORNER	ATI518SA
MS21074-06	CORNER	ATI518SB
MS21074-08	CORNER	ATI518SC
MS21074-3	CORNER	ATI518SD
MS21074-4	CORNER	ATI518SE
MS21074-5	CORNER	AT518NASCA5

SHORT LUG

Nutplate Spec	Style	Part Number
NAS1789-08	SHORT LUG	AT518NSDA08
NAS1789-3	SHORT LUG	ATI518TA
NAS1789-4	SHORT LUG	ATI518TB
NAS1789-5	SHORT LUG	ATI518TD
NAS1789-6	SHORT LUG	AT518NASDA6



SAFETY PRECAUTION: Read and follow all safety and operating instructions.
WARNING: Face & eye protection must be worn while operating power tools, per ANSI B186.1

COMPARE THE DIFFERENCE

Ground on-centers to ensure concentricity and eliminate run out



Two cutting flutes for maximum chip relief; three flutes to eliminate chatter

120-degree seating angle for standard fit

Manufactured of M2 high-speed steel

1/4"-28 Threaded male shank

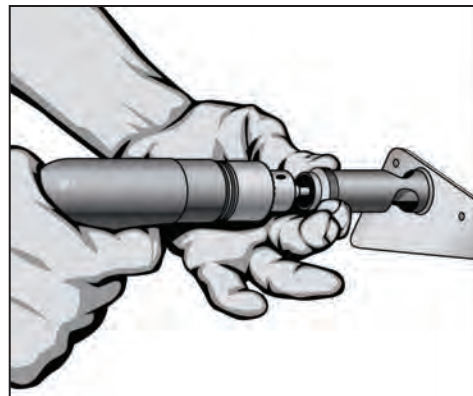

Recognized throughout the industry as the leading producer of quality cutting tools, ATI Tools continues an intensive research program to improve products through advanced design and manufacturing techniques.

The tools contained in this section are made of the finest materials. The cutters are carefully heat-treated, precision ground for correct cutting angles and proper clearance, then thoroughly checked to ensure accurate cutting without chatter. All tools are dipped in a protective plastic coating for shipment and storage.

A variety of microstop countersink units and accessories have been designed to present a versatile selection of tools for all working surfaces and areas. Opportunities to analyze and assist with individual cutting problems are welcomed by ATI's engineering staff.

Anatomy of a Countersink

A countersink is a tool used to cut and form a hole so that a flush fastener can be installed. The main features of a countersink are the threaded shank, body, cutting angle, and pilot.

Threaded Shank

The threaded shank is inserted into the microstop shaft and its thread size is specified by the user. Industry standard thread sizes are 10-32, 1/4"-28, 3/8"-24, and 7/16"-20. The most common countersink shanks are 1/4"-28.

Body

The body of a countersink is typically cylindrical in shape and its diameter is determined by the fastener to be installed.

Cutting Angle

The cutting angle is determined by the fastener to be installed and is specified by the user. The cutting angle also indicates what the angle of the conically shaped hole will be when the hole is formed. The most common cutting angle is 100 degrees.

Pilot

The pilot diameter on a countersink is specified by the user and typically is the same diameter of the pre-drilled hole. It's important for the pilot end to be smooth and to have a hemispherical tip in order to prevent scratching. The pilot acts like a guide when it is inserted into the pre-drilled hole (called the "pilot hole"). The pilot facilitates countersinking by properly aligning the countersink to the target hole.

The Countersink Cutter

The countersink cutter rotates at a very high speed and removes material to form a hole shaped like an inverted cone. This hole is cut to form the exact specifications of the fastener to be installed.

Extreme Precision and Accuracy

The microstop controls the countersink's depth with precise accuracy. Typically, the depth of cut is adjustable in increments of .001 inch, with more precise microstops available in .0005-inch increments. Once the microstop and countersink assembly is configured for the job, the assembly can be used hundreds of times with repeatable results.

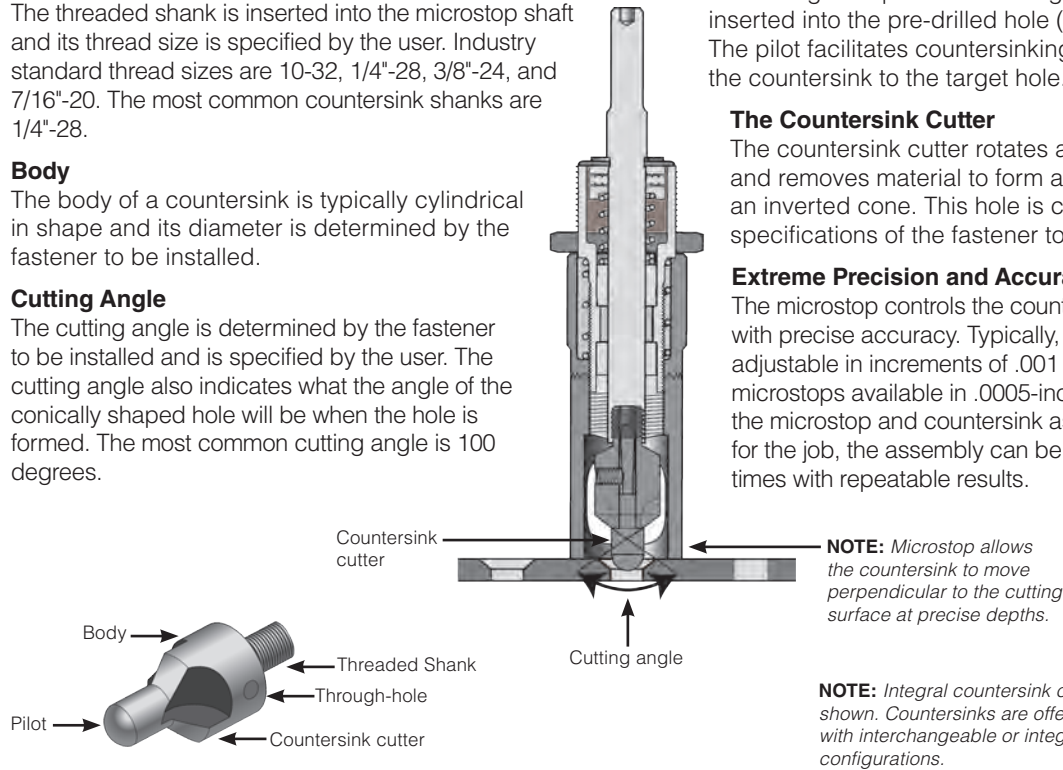

What is a Microstop and What Does it Do?

A "microstop" is a cylindrical tool that holds a cutting tool known as a "countersink."

The microstop allows the countersink to move perpendicular to the cutting surface at precise depths. When countersinking, the microstop can make "micro" adjustments up and down, and "stop" the countersink at the exact depth to match the profile of the fastener to be installed. The countersink depth is controlled by rotating the microstop skirt. The adjustments are extremely precise. Rotating the countersink skirt adjusts the countersink depth by only 0.0005 in.

Extreme precision is important when countersinking a hole because it enables the ultimate objective: to ensure that the fastener – typically a flush rivet – fills the countersunk hole completely. Usually a rivet gun is used for installing and deforming the flush rivet into the hole's geometry.

When each countersunk hole is precisely drilled and fasteners are properly installed, every part of the plane's skin has consistent strength and load distribution. The use of a microstop allows for uniformity and helps achieve this goal.

A versatile tool, a microstop works with any type of threaded shank cutter in applications where the depth of cut requires extreme precision. This would include countersinks, counterbores, and hollow cutters, just to name a few.

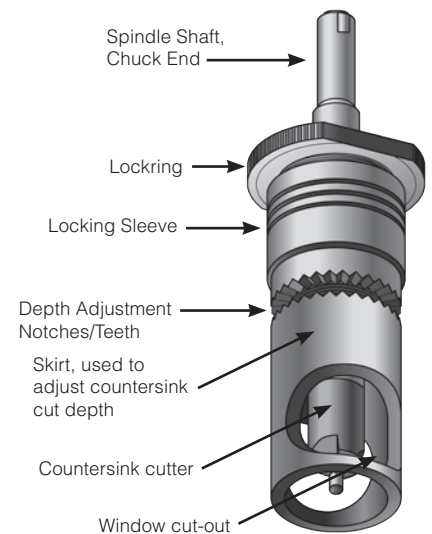

NOTE: Skirt remains stationary when in contact with the cutting surface, enabling the operator to view the cutter.

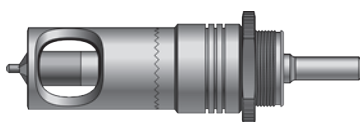

"Microstop & Countersink Cutter" in advanced position

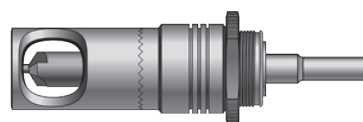

"Microstop & Countersink Cutter" in retracted position

CUTTING TOOLS AND MICROSTOPS

COUNTERSINK CUTTERS, INTEGRAL PILOT



- Manufactured of M2 high-speed steel or carbide-tipped
- High speed steel countersinks ground on-centers to insure concentricity
- 120-degree seating angle for standard fit
- Use with ATI444 or ATI443 Series microstops

HSS COUNTERSINKS, INTEGRAL PILOT, 100 DEGREE, 1/4"-28 THREADS

Pilot Diameter	Decimal Equivalent	Number of Flutes	Body Diameter			
			3/8"	7/16"	1/2"	5/8"
3/32"	.0938	2		ATI445D4-532	ATI445E43/32	
		3	ATI420C4332	ATI420D43/32	ATI420E43/32	
#41	.0960	2				ATI445G441N
		3	ATI420C4.096			
#40	.0980	2	ATI445C-4-40		ATI445E440	
		3	ATI420C440	ATI420D440	ATI420E440	
1/8"	.1250	2	ATI445C41/8		ATI445E41/8	
		3	ATI420C418	ATI420D41/8	ATI420E418	
#30	.1285	2	ATI445C430		ATI445E430	ATI445G430
		3	ATI420C430	ATI420D430	ATI420E430	
9/64"	.1406	2			ATI445E4964	
		3	ATI420C4964	ATI420D49/64		
#27	.1440	2	ATI445C427		ATI445E427	
		3		ATI420D427		ATI420G427
5/32"	.1563	2			ATI445E43/32	
		3	ATI420C45/32	ATI420D45/32	ATI420E45/32	
#21	.1590	2	ATI445C-4-21		ATI445E421	
		3	ATI420C421	ATI420D421	ATI420E421	
#20	.1610	2			ATI445E420	
		3	ATI420C420	ATI420D420	ATI420E420	
11/64	.1719	2	ATI445C41164			
		3	ATI420C41164	ATI420D41164		
#16	.1770	2			ATI445E416	
		3		ATI420D416	ATI420E4177	ATI420G416
#13	.1850	2			ATI445E413	
		3	ATI420C413	ATI420D413	ATI420E413	ATI420G413
3/16"	.1875	2	ATI445C4-316		ATI445E43/16	
		3	ATI420C4316	ATI420D43/16	ATI420E43/16	ATI420G43/16
#11	.1910	2			ATI445E4-11	
		3		ATI420D411	ATI420E411	
#10	.1935	2	ATI445C-4-10		ATI445E410	
		3	ATI420C410	ATI420D410	ATI420E410	
#8	.1990	2			ATI445E48	
		3			ATI420E48	ATI420G4N8
7/32"	.2188	2			ATI445E47/32	
		3		ATI420D47/32	ATI420E47/32	
#2	.2210	2	ATI445C42N			
		3				
1/4"	.2500	2			ATI445E4-1/4	ATI445G41/4
		3	ATI420C41/4	ATI420D41/4	ATI420E41/4	ATI420G4-1/4
5/16"	.3125	2			ATI445E45/16	ATI445G45/16
		3	ATI420C45/16	ATI420D45/16		ATI420G45/16
11/32"	.3438	2			ATI445E41132	
		3				
3/8"	.3750	2			ATI445E43/8	ATI445G43/8
		3				ATI420G43/8
1/2"	.5000	2				ATI445G41/2
		3				

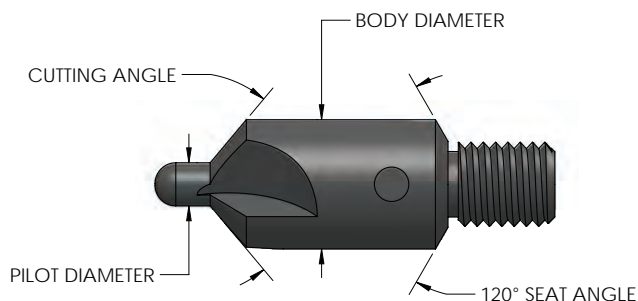

HSS COUNTERSINKS, INTEGRAL PILOT, 100 DEGREE, 1/4"-28 THREADS

Pilot Diameter	Decimal Equivalent	Number of Flutes	BODY DIAMETER		
			1/4"	1/4" (10-32 THD)	5/16"
3/32"	.0938	2		ATI445A4332S	
		3	ATI420A4332		ATI420B43/32
#40	.0980	2	ATI445A4-40N	ATI445A440S2	
		3	ATI420A440		
#30	.1285	2	ATI445A-4-30	ATI445A430S2	
		3			
9/64"	.1406	2			
		3			ATI420B49/64
5/32"	.1563	2			
		3			ATI420B45/32
	.1620	2			ATI445B41620
		3			
3/16"	.1875	2			
		3			ATI420B43/16

Special countersink cutters may be ordered by providing the material, body diameter, pilot diameter, number of flutes, and cutting angle.



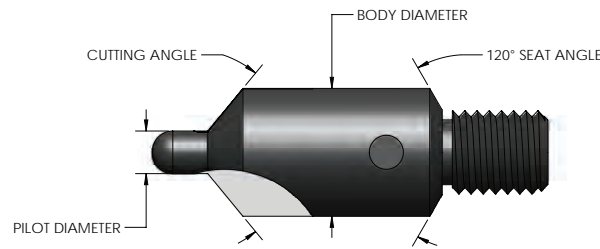

CARBIDE-TIPPED COUNTERSINKS, INTEGRAL PILOT, 2-FLUTE, 100 DEGREE, 1/4"-28 THREADS

Pilot Diameter	Decimal Equivalent	Body Diameter	Part Number
3/32"	.0938	1/2"	ATI445CE4332
#40	.0980	1/4"	ATI445CTA440 (10-32 THDS)
		1/2"	ATI445CE440N
1/8"	.1250	1/2"	ATI445CTE418
#30	.1285	1/2"	ATI445CTE430
9/64"	.1406	1/2"	ATI445CE4964
5/32"	.1563	1/2"	ATI445CE4532
	.1580	1/2"	ATI445CE4158
#21	.1590	3/8"	ATI445CC421
		1/2"	ATI445CTE421
#20	.1610	1/2"	ATI445CE420N
#19	.1660	7/16"	ATI445CD419N
		1/2"	ATI445CE419N
#16	.1770	3/8"	ATI445CC416
		1/2"	ATI445CE416N
#13	.1830	1/2"	ATI445CE4183
	.1850	1/2"	ATI445CE413N
	.1860	1/2"	ATI445CE4186
3/16"	.1875	1/2"	ATI445CE4316
	.1880	1/2"	ATI445CE4188
#11	.1910	1/2"	ATI445CE411N
	.1920	1/2"	ATI445CE4192
#10	.1935	1/2"	ATI445CTE410
#9	.1960	1/2"	ATI445CE49N
#8	.1990	1/2"	ATI445CE4199

Pilot Diameter	Decimal Equivalent	Body Diameter	Part Number
13/64"	.2031	1/2"	ATI445CE1364
#3	.2130	1/2"	ATI445CE43N
	.2150	1/2"	ATI445CE4215
7/32"	.2188	1/2"	ATI445CE4732
#2	.2210	1/2"	ATI445CE42N
	.2430	1/2"	ATI445CE4243
D	.2460	1/2"	ATI445CE4246
	.2470	1/2"	ATI445CE4247
	.2475	1/2"	ATI445CTESP1
	.2480	1/2"	ATI445CE4248
1/4"	.2500	1/2"	ATI445CTE414
		5/8"	ATI445CG414
9/32"	.2620	1/2"	ATI445CE4262
	.2780	1/2"	ATI445CE4278
	.2813	1/2"	ATI445CE4932
	.3090	1/2"	ATI445CE4309
	.3100	1/2"	ATI445CE4310
	5/16"	.3125	1/2"
5/8"			ATI445CG4516
.3240		1/2"	ATI445CE4324
.3250		1/2"	ATI445CE4325
3/8"	.3400	1/2"	ATI445CE4340
	.3420	1/2"	ATI445CE4342
	.3710	1/2"	ATI445CE4371
	.3750	1/2"	ATI445CE438

Special countersink cutters may be ordered by providing the material, body diameter, pilot diameter, number of flutes, and cutting angle.

COUNTERSINK CUTTER SETS WITH ANODIZED HOLDER

Part Number	Description
ATI420D-4PC	4-PC Set Includes: ATI420D43/32, ATI420D41/8, ATI420D45/32, ATI420D43/16
ATI420D-5PC	5-PC Set Includes: ATI420D43/32, ATI420D41/8, ATI420D45/32, ATI420D43/16, ATI420D41/4
ATI420D-9PC	9-PC Set Includes: ATI420D43/32, ATI420D41/8, ATI420D45/32, ATI420D43/16, ATI420D440, ATI420D430, ATI420D421, ATI420D410
ATI445E-4PC	4-PC Set Includes: ATI445E43/32, ATI445E41/8, ATI445E45/32, ATI445E43/16
ATI445E-5PC	5-PC Set Includes: ATI445E43/32, ATI445E41/8, ATI445E45/32, ATI445E43/16, ATI445E41/4
ATI445E-9PC	9-PC Set Includes: ATI445E43/32, ATI445E41/8, ATI445E45/32, ATI445E43/16, ATI445E440, ATI445E430, ATI445E421, ATI445E410



MICROSTOP/COUNTERSINK CUTTER KIT

ATI590CSK

- Provides countersinking versatility
- Includes one ball-bearing, .0005 adjustable depth Microstop for precise, accurate countersinking
- Includes an assortment of popular skirt and nose piece configurations
- Includes nine 1/2" diameter, 100° cutters with pilots of #40, #30, #21, #10, 3/32", 1/8", 5/32", 3/16", and 1/4"



SAFETY PRECAUTION: Read and follow all safety and operating instructions.
WARNING: Face & eye protection must be worn while operating power tools, per ANSI B186.1

CUTTING TOOLS AND MICROSTOPS REPLACEABLE PILOT COUNTERSINK CUTTERS



ATI455 SERIES, HIGH SPEED STEEL, 100°, 1/4"-28 THREADED SHANK

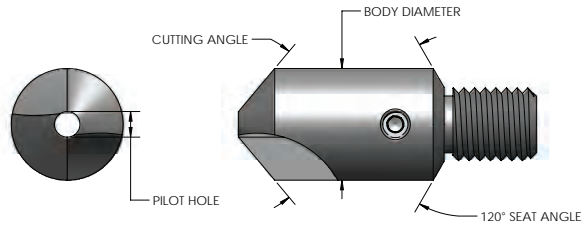

Refer to ATI484 Series and ATI435 series replaceable pilots.

Part Number	Body Diameter	Pilot Hole Diameter	Number of Flutes
ATI455A-4	1/4"	.086	2
ATI455B-4	5/16"	.086	2
ATI455C-4	3/8"	.086	2
ATI455D-4	7/16"	.086	2
ATI455E-4	1/2"	.086	2
ATI455F-4	9/16"	.086	2
ATI455G-4	5/8"	.086	2
ATI455H-4*	3/4"	.170	3
ATI455J-4*	7/8"	.170	3

*3/8"-24 threaded shanks

Special countersink cutters may be ordered by providing the material, body diameter, pilot hole diameter, and cutting angle.

ATI455CT SERIES, CARBIDE-TIPPED, 100°, 1/4"-28 THREADED SHANK

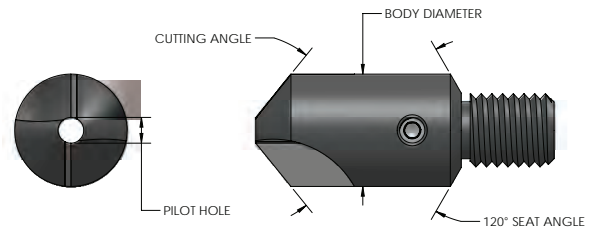

Refer to ATI485 Series replaceable pilots.

Part Number	Body Diameter	Pilot Hole Diameter	Number of Flutes
ATI455CTC-4	3/8"	.125	2
ATI455CTE-4	1/2"	.125	2
ATI455CTG-4	5/8"	.125	2

COUNTERSINK CUTTER FOR KEVLAR

ATI455SK SERIES, 1/4"-28 THREADED SHANK

The Kevlar countersink cutter is designed for use with DuPont Kevlar composites. The unique 'S' shaped positive rake cutting flutes produce fuzz-free countersinks of precision quality in Kevlar.

Part Number	Body Diameter	Pilot Hole Diameter
ATI455SKE-4	1/2"	.086
ATI455SKG-4	5/8"	.086

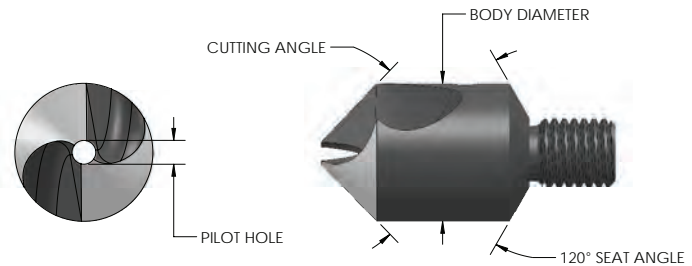

COUNTERSINK CUTTER, POLYCRYSTALLINE DIAMOND INSERT FOR COMPOSITE MATERIAL

ATI455PD SERIES, REPLACEABLE PILOT, 100°, 1/4"-28 THREADED SHANK

The ATI455PD Series countersinks excel in cutting highly abrasive, non-ferrous materials where carbide will not perform, such as graphite epoxy composites. Replaceable pilot design allows for economical replacement of damaged pilots and versatility of various pilot diameters with the same cutter.

Part Number	Body Diameter	Pilot Hole Diameter
ATI455PDE-4	1/2"	.125
ATI455PDG4	5/8"	.125
ATI455PDH-4	3/4"	.170

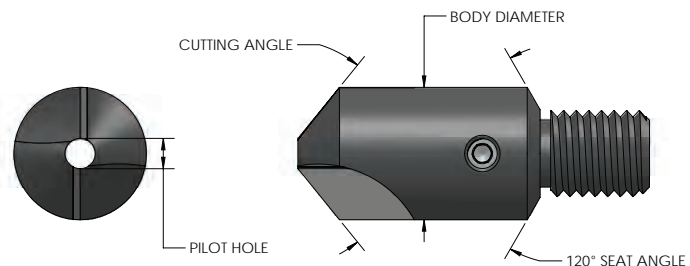

- Manufactured of M42 cobalt steel
- Ground on-centers to insure concentricity
- 120-degree seating angle for standard fit
- Use with ATI444 Series microstops

ATM6 SERIES

Integral pilot cutter with M6 X 1.00 metric male threaded shank for use with ATI444 Series microstops.

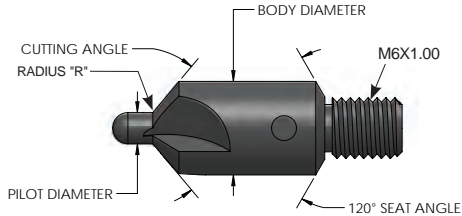

WHEN ORDERING SPECIFY:

BODY DIAMETER, ANGLE, PILOT DIAMETER, FILLET RADIUS, AND CUTTING FLUTES
ATM6-"D"- "A"- "PILOT DIAMETER"- "R"- 2 OR 3 FLUTES

Ex. ATM6104317P2

Body Diameter	"D"	C'sink Angle	"A"	Radius Code	"R"	Standard Pilot Diameters (MM)	
6	6MM	1	78°	P	.50MM	2.38	4.76
8	8MM	2	82°	Q	.75MM	2.50	4.80
10	10MM	3	90°	R	1.00MM	3.17	5.00
12	12MM	4	100°			3.50	5.60
14	14MM	5	110°			3.96	6.00
		6	115°			4.00	6.35
		7	120°				
		8	130°				

Note: Other pilot sizes available upon request.

ATM8 SERIES

Integral pilot cutter with M8 X 1.00 metric male threaded shank for use with ATI444 Series microstops.

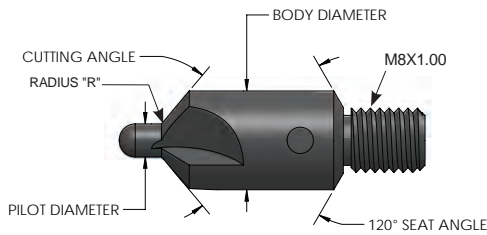

WHEN ORDERING SPECIFY:

BODY DIAMETER, ANGLE, PILOT DIAMETER, FILLET RADIUS, AND CUTTING FLUTES
ATM8-"D"- "A"- "PILOT DIAMETER"- "R"- 2 OR 3 FLUTES

Ex. ATM8144600Q3

Body Diameter	"D"	C'sink Angle	"A"	Radius Code	"R"	Standard Pilot Diameters (MM)	
10	10MM	1	78°	P	.50MM	2.38	4.80
12	12MM	2	82°	Q	.75MM	2.50	5.00
14	14MM	3	90°	R	1.00MM	3.17	5.60
17	17MM	4	100°			3.50	6.00
21	21MM	5	110°			3.96	6.35
		6	115°			4.00	8.00
		7	120°			4.76	10.00
		8	130°				

Note: Other pilot sizes available upon request.

COUNTERSINK CUTTERS, INTERCHANGEABLE PILOT, METRIC

ATM6IP SERIES

Standard 2 Flute interchangeable pilot cutter with M6 X 1.00 metric male threaded shank and .086 pilot hole for use with ATI444 Series microstops.

Refer to ATI484 Series Pilots

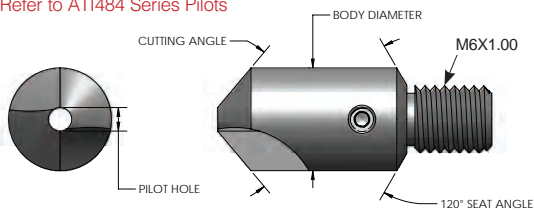

WHEN ORDERING SPECIFY: BODY DIAMETER AND ANGLE

ATM6IP-"D"- "A"

Ex. ATM6IP124

Body Diameter	"D"	C'sink Angle	"A"
10	10MM	1	78°
12	12MM	2	82°
14	14MM	3	90°
17	17MM	4	100°
		5	110°
		6	115°
		7	120°
		8	130°

ATM8IP SERIES

Standard 2 Flute interchangeable pilot cutter with M8 X 1.00 metric male threaded shank and .086 pilot hole for use with ATI444 Series microstops.

Refer to ATI484 Series Pilots

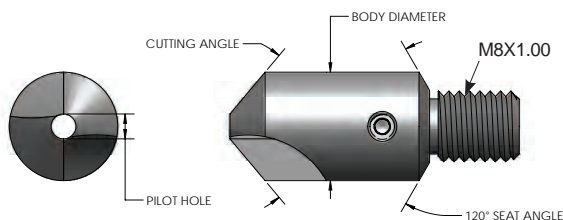

WHEN ORDERING SPECIFY: BODY DIAMETER AND ANGLE

ATM8IP-"D"- "A"

Ex. ATM8IP144

Body Diameter	"D"	C'sink Angle	"A"
10	10MM	1	78°
12	12MM	2	82°
14	14MM	3	90°
17	17MM	4	100°
21	21MM	5	110°
		6	115°
		7	120°
		8	130°

*21MM comes w/ 3 flutes & .170 pilot hole



SAFETY PRECAUTION: Read and follow all safety and operating instructions.

WARNING: Face & eye protection must be worn while operating power tools, per ANSI B186.1

CUTTING TOOLS AND MICROSTOPS

PILOTS



ATI484 SERIES

Used with ATI455, ATM6IP, ATM8IP Series cutters

Part Number	Pilot Diameter	Shank Diameter	Part Number	Pilot Diameter	Shank Diameter
ATI484-2	#40	.086	ATI484-2.38M	2.38MM	.086
ATI484-12	#30	.086	ATI484-2.50M	2.50MM	.086
ATI484-21	#21	.086	ATI484-3.17M	3.17MM	.086
ATI484-31	#11	.086	ATI484-3.50M	3.50MM	.086
ATI484-32	#10	.086	ATI484-3.96M	3.96MM	.086
ATI484-56	3/32	.086	ATI484-4.00M	4.00MM	.086
ATI484-57	1/8	.086	ATI484-4.76M	4.76MM	.086
ATI484-59	5/32	.086	ATI484-4.80M	4.80MM	.086
ATI484-61	3/16	.086	ATI484-5.00M	5.00MM	.086
ATI484-63	7/32	.086	ATI484-5.60M	5.60MM	.086
ATI484-65	1/4	.086	ATI484-6.00M	6.00MM	.086

Special size pilot diameters are available upon special request.

These replaceable pilots have a flat on the shank to accommodate cutters with a set screw, and an undercut to permit head-to-seat on cutter angle.

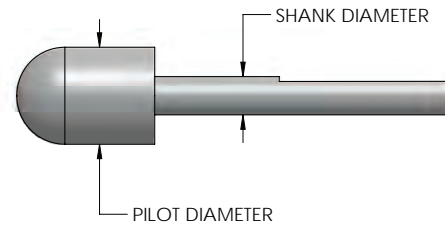

ATI485 SERIES

Used with ATI455CT, ATI455PD Series cutters

Part Number	Pilot Diameter	Shank Diameter
ATI485-12	#30	.125
ATI485-21	#21	.125
ATI485-31	#11	.125
ATI485-32	#10	.125
ATI485-57	1/8	.125
ATI485-59	5/32	.125
ATI485-61	3/16	.125
ATI485-63	7/32	.125
ATI485-65	1/4	.125

Special size pilot diameters are available upon special request.

ATI435 SERIES

Used with ATI455 Series cutters

Part Number	Pilot Diameter	Shank Diameter
ATI435-3/16	3/16	.170
ATI435-1/4	1/4	.170
ATI435-5/16	5/16	.170
ATI435-3/8	3/8	.170
ATI435-1/2	1/2	.170

Special size pilot diameters are available upon special request.

BRILES® COUNTERSINK CUTTERS

ATI438BRC SERIES, 1/4"-28 THREADED SHANK

These high speed steel countersinks feature a unique design that cuts a counterbore and countersink in the same hole. Use these special countersinks to prepare holes for MS14218, Briles® Rivet BRFZ, and Boeing BACR15FV.

Part Number	"A"	"B"	"C"	"H"	"J"
ATI438BRC3	.1235	.096	.375	.949	.180
ATI438BRC-4	.1625	.126	.375	.952	.200
ATI438BRC-5	.2105	.159	.375	.955	.220
ATI438BRC-6	.2585	.191	.375	.958	.250
ATI438BRC-7	.3125	.226	.375	.962	.280
ATI438BRC-8	.3585	.255	.500	.966	.280
ATI438BRC9	.4055	.288	.500	.969	.300
ATI438BRC10	.4545	.314	.500	.972	.300

Used with ATI444 SERIES microstops.

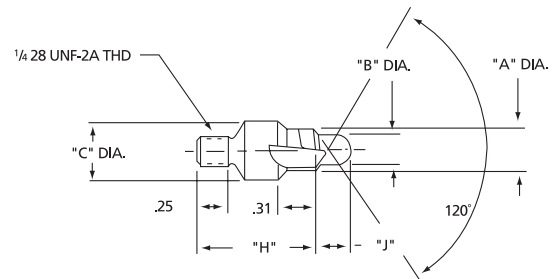

ATI438BRC-8

COUNTERSINK CUTTER EXTENSIONS, 1/4"-28 RECESS

Part Number	Shank Diameter	Body Diameter	Body Length
ATI470B-75	1/4" Straight	1/2"	0.75"
ATI470B-1.0	1/4" Straight	1/2"	1.0"
ATI470B-1.5	1/4" Straight	1/2"	1.5"
ATI470B-3.0	1/4" Straight	1/2"	3.0"
ATI470B1	1/4" Straight	1/2"	4.0"
ATI470B1F	1/4" Straight with Flats	1/2"	4.0"
ATI470B-2	1/4" Straight	1/2"	6.0"
ATI470B-2F	1/4" Straight with Flats	1/2"	6.0"
ATI470B-8.0	1/4" Straight	1/2"	8.0"
ATI470C-1	1/4"-28 Thread	3/8"	1.0"
ATI470C-2	1/4"-28 Thread	3/8"	2.0"
ATI470C-3	1/4"-28 Thread	3/8"	3.0"
ATI470C-4	1/4"-28 Thread	3/8"	4.0"
ATI470C-5	1/4"-28 Thread	3/8"	5.0"
ATI470C-6	1/4"-28 Thread	3/8"	6.0"
ATI470C-12	1/4"-28 Thread	3/8"	12.0"



ATI470B1



SAFETY PRECAUTION: Read and follow all safety and operating instructions.

WARNING: Face & eye protection must be worn while operating power tools, per ANSI B186.1

FOR COUNTERSINK CUTTERS THREADED 1/4"-28, M6 X 1, AND M8 X 1
(Refer to ATI420, ATI438, ATI445, ATI455, ATI463, ATM6, ATM8 countersink cutters)



Microstop - Ball Bearing



Cutaway View



Microstop - Bushing



Cutaway View

ATI444 MICROSTOPS

- For high volume, accurate countersinking in a production environment
- Full ball bearing shaft support for increased life
- Heavy duty ball thrust bearing ensures depth repeatability
- Fail-safe design accomplished with integrated shoulder on shaft
- Debris filter prevents chips and dust from contaminating bearings
- .0005" depth adjustment, 5/16" shaft travel
- Right-hand threaded lock nut prevents jamming of adjustment mechanism
- Multiple skirt configuration options
- Multiple shaft configuration options

ATI443 MICROSTOPS

- For lower volume countersinking in maintenance and home-build environments
- Bronze bushing shaft support
- Heavy duty ball thrust bearing ensures depth repeatability
- Fail-safe design accomplished with integrated shoulder on shaft
- .0005" depth adjustment, 5/16" shaft travel
- Right-hand threaded lock nut prevents jamming of adjustment mechanism.
- Multiple skirt configuration options
- Multiple shaft configuration options

SKIRTS:

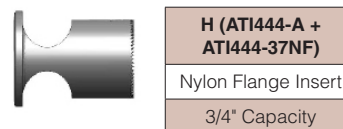
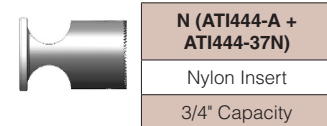
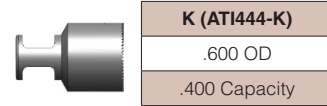
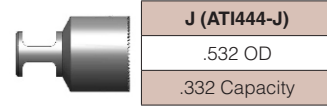
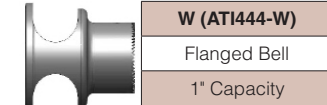
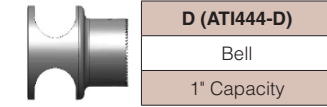
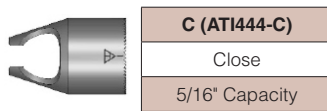
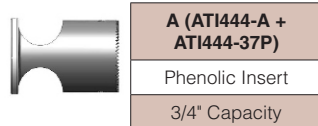
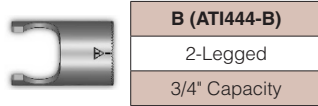
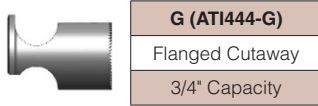
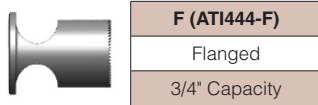
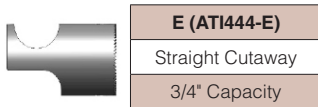
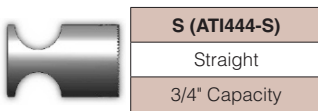

EXTENDED SKIRTS:
2-3/4" Extension
(Includes extension shaft)

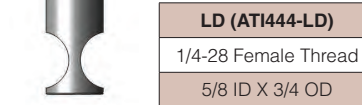
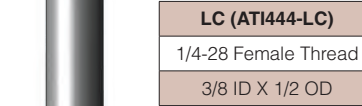
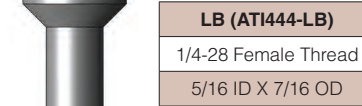
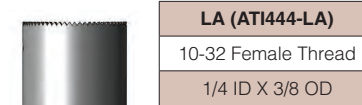

SHAFTS: All shafts feature wrenching flats to aid in removal of cutter after use.

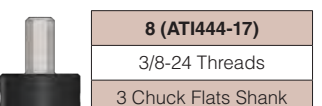
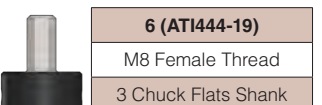
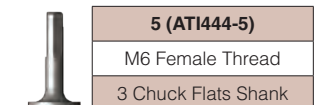
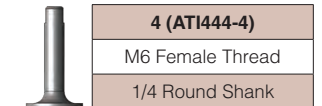
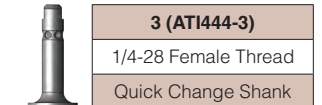
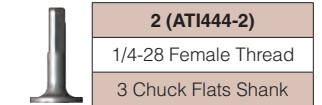
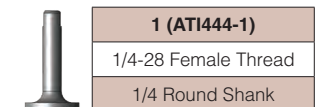

INSERT CHART

Part Number	O.D.	I.D.	Material	
ATI444-37P	.960	.775	Phenolic	Used with ATI444A Series Microstop
ATI444-37N	.960	.775	Nylon	Used with ATI444A or ATI444N Series Microstop
ATI444-37NF	1.25	.775	Nylon	Used with ATI444A or ATI444H Series Microstop

ORDERING: Choose either ATI444 or ATI443, Skirt Option, and Shaft Option.

Part Number	MODEL / SKIRT / SHAFT
Ex. ATI444G2	ATI444 + G + 2
Ex. ATI444LA4	ATI444 + LA + 4
Ex. ATI443S1	ATI443 + S + 1
Ex. ATI443A2	ATI443 + A + 2

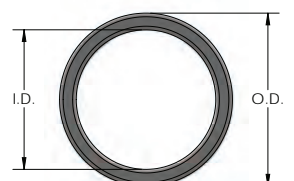

SAFETY PRECAUTION: Read and follow all safety and operating instructions.
WARNING: Face & eye protection must be worn while operating power tools, per ANSI B186.1

MICROSTOP FOR FEMALE-THREADED COUNTERSINK CUTTERS

Refer to ATI418 series cutters and ATI416 series pilots

ATI442S1

Uses 1/4"-28 threaded shaft which is split and tapered to lock replaceable pilot securely when cutter is tightened.



MICROSTOP COUNTERSINK CAGES, SWIVEL SHAFT
ATI2351 SERIES

The swivel shaft design enables you to countersink with up to a 5 degree off angle between the spindle and cutter axis. Designed for use on all standard materials as well as the latest composite materials in the most demanding applications. Ball and thrust bearings for continuous high speed use and .0005 adjustable depth control. Available with 1/4"-28 or metric threads; standard or flanged skirts, optional nylon inserts.

Part Number	Description
ATI2351S1	Standard Skirt, 1/4"-28 Shaft
ATI2351S4	Standard Skirt, M6 Shaft
ATI2351N1	Standard Skirt, 1/4"-28 Shaft, Nylon Insert
ATI2351N4	Standard Skirt, M6 Shaft, Nylon Insert
ATI2351F1	Flanged Skirt, 1/4"-28 Shaft
ATI2351F4	Flanged Skirt, M6 Shaft
ATI2351H1	Flanged Skirt, 1/4"-28 Shaft, Nylon Insert
ATI2351H4	Flanged Skirt, M6 Shaft, Nylon Insert



MICROSTOP COUNTERSINK CAGES, STUBBY

Designed for close quarter or tight access applications

ATI448 SERIES

- 3/32" Shaft Travel
- .001 Adjustable Depth Control

Part Number	D	L	Shaft	Max. Cutter Diameter
ATI448S1	.560	1.22"	1/4"-28	1/2"
ATI448S3	.560	1.22"	QC	1/2"

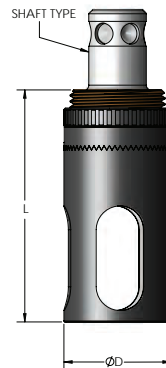

*image shown is with quick-change shaft

MICROSTOP COUNTERSINK CAGES, MIDGET

Designed for close quarter or tight access applications

ATI449 SERIES

- 9/32" Shaft Travel
- .001 Adjustable Depth Control

Part Number	D	L	Shaft	Max. Cutter Diameter
ATI449S1	.560	1.62"	1/4"	1/2"
ATI449S3	.560	1.62"	QC	1/2"

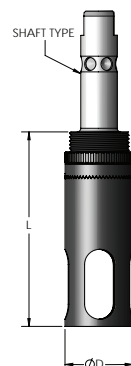

*image shown is with quick-change shaft

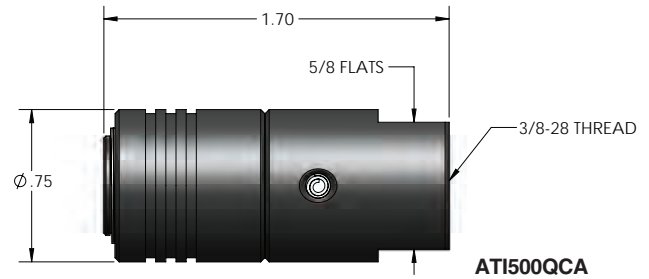
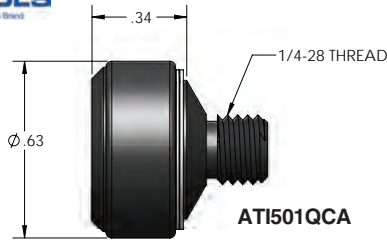

Part Number	Type	Description
ATI501QCA	STUBBY	Designed to fit any standard angle drill with 1/4"-28 threaded spindle
ATI500QCA	STANDARD	Designed to fit any standard drill motor with 3/8"-24 threaded chuck spindle

JUMBO SIZE MICROSTOPS

FOR COUNTERSINK CUTTERS THREADED 3/8"-24 and 7/16"-20
(Refer to ATI445 and ATI455 series countersink cutters)

- For production environment countersinking of larger sized holes
- Fail-safe design accomplished with integrated shoulder on shaft
- All shafts feature wrenching flats to aid in removal of cutter after use
- 3/4" shaft travel
- Ball thrust bearing ensures depth repeatability



Part Number	Shaft Thread	Shaft Support	Adjustment Increment	Cutter Capacity	Shank	OAL
ATI432A	7/16"-20 Female	Bronze Bushing	.001	1-1/4"	3/8" Round	7"
ATI432B	3/8"-24 Female	Bronze Bushing	.001	1-1/4"	3/8" Round	7"
ATI462	3/8"-24 Female	Bronze Bushing	.003	7/8"	3/8" Round	5"
ATI462H3-1.3	3/8"-24 Female	Ball Bearing	.0005	1-1/4"	3 Chuck Flats	5"
ATI462H3-1.5	3/8"-24 Female	Ball Bearing	.0005	1-3/8"	3 Chuck Flats	5"
ATI462H7-1.3	7/16"-20 Female	Ball Bearing	.0005	1-1/4"	3 Chuck Flats	5"
ATI462H7-1.5	7/16"-20 Female	Ball Bearing	.0005	1-3/8"	3 Chuck Flats	5"

ELLIPTICAL FASTENER COUNTERSINK CUTTER KIT

ATI2200CSK

This kit provides countersinking capabilities for the installation of the NAS1734 or NAS1735 elliptical head blind nuts, for fasteners -3 (#10) thru -8 (1/2") hole preparation in accordance with NAS1736. Use with common hand-held drill motors.

Kit includes ATISK2260 and ATISK2266 microstops with stabilizing rockers and four cobalt cutters.

Qty	Part Number	Description
1	ATISK2260	Microstop with wobble skirt and arm assembly, 1/4"-28 threaded shank, 1/2" maximum cutter diameter for fasteners #10, 1/4", and 5/16".
1	ATISK2266	Jumbo Microstop with wobble skirt and arm assembly, 3/8"-24 threaded shank, 3/4" maximum cutter diameter for fasteners 3/8", 7/16", and 1/2".
1	ATISK2266B	Jumbo Microstop with wobble skirt and arm assembly, 3/8"-24 threaded shank, 1-1/4" maximum cutter diameter for fasteners 3/4", 7/8" and 1-1/4".
1	C15374-3	Elliptical nut countersink assembly, #10
1	C15374-4	Elliptical nut countersink assembly, 1/4"
1	C15374-5	Elliptical nut countersink assembly, 5/16"
1	C15374-6	Elliptical nut countersink assembly, 3/8"



Other elliptical nut countersink assemblies available upon special request.



SAFETY PRECAUTION: Read and follow all safety and operating instructions.
WARNING: Face & eye protection must be worn while operating power tools, per ANSI B186.1

CUTTING TOOLS AND MICROSTOPS

BACK COUNTERSINK CUTTERS



ATI402 SERIES

Used in restricted areas where direct countersinking is not possible.
A four-flute, one piece unit used with ATI404 Series Pilot

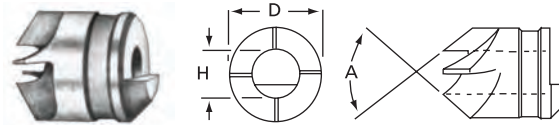

Part Number	Body Diameter	Pilot Hole	Angle
ATI402A-4	1/4"	1/8"	100°
ATI402B-4	1/4"	3/32"	100°
ATI402C-4	5/16"	1/8"	100°
ATI402D-4	5/16"	5/32"	100°
ATI402E-4	3/8"	3/16"	100°
ATI402F-4	3/8"	5/32"	100°
ATI402G-4	7/16"	3/16"	100°
ATI402H-4	7/16"	5/32"	100°
ATI402I-4	1/2"	3/16"	100°
ATI402J-4	1/2"	1/4"	100°
ATI402K-4	9/16"	3/16"	100°
ATI402L-4	9/16"	1/4"	100°
ATI402M-4	5/8"	1/4"	100°
ATI402N-4	5/8"	5/16"	100°
ATI402O-4	11/16"	1/4"	100°
ATI402P-4	11/16"	5/16"	100°
ATI402Q-4	3/4"	1/4"	100°
ATI402R-4	3/4"	5/16"	100°
ATI402S-4	7/8"	5/16"	100°
ATI402T-4	7/8"	3/8"	100°
ATI402U-4	1"	5/16"	100°
ATI402V-4	1"	3/8"	100°
ATI402W-4	1-1/4"	3/8"	100°
ATI402X-4	1-1/4"	1/2"	100°



ATI590TA BACK COUNTERSINK KIT

Compact kit for shop or field service requirement.
Contains 8 cutters and 8 gunlock pilots.

Part No.	QTY	Part No.	QTY
ATI402B-4	1	ATI404-1	1
ATI402C-4	1	ATI404-2	1
ATI402F-4	1	ATI404-3	1
ATI402I-4	1	ATI4044	1
ATI402Q-4	1	ATI4045	1
ATI402S-4	1	ATI404-6	1
ATI402V-4	1	ATI404-7	1
ATI402X-4	1	ATI404-8	1

BACK SPOTFACER CUTTERS

ATI403 SERIES

For reverse spotfacing and counterboring in confined areas where one piece straight shank tools cannot be used. Designed with four cutting edges with .030R corner radii. Used with ATI404 Series Pilots.

Part Number	Body Diameter	Pilot Hole
ATI403A	1/4"	3/32"
ATI403B	1/4"	1/8"
ATI403C	5/16"	1/8"
ATI403D	5/16"	5/32"
ATI403E	3/8"	3/16"
ATI403F	3/8"	5/32"
ATI403G	7/16"	3/16"
ATI403H	7/16"	5/32"
ATI403I	1/2"	3/16"
ATI403J	1/2"	1/4"
ATI403K	9/16"	3/16"
ATI403L	9/16"	1/4"
ATI403M	5/8"	1/4"
ATI403N	5/8"	5/16"
ATI403O	11/16"	1/4"
ATI403P	11/16"	5/16"
ATI403Q	3/4"	1/4"
ATI403R	3/4"	5/16"
ATI403S	7/8"	5/16"
ATI403T	7/8"	3/8"
ATI403U	1"	5/16"
ATI403V	1"	3/8"
ATI403W	1-1/4"	3/8"
ATI403X	1-1/4"	1/2"

Note: Other radii available upon special order

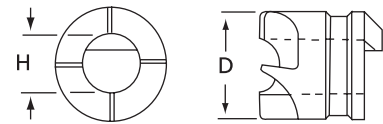

ATI590S BACK SPOTFACER KIT

Compact kit for shop or field service requirement.
Contains 8 cutters and 8 gunlock pilots.

Part No.	QTY	Part No.	QTY
ATI403A	1	ATI404-1	1
ATI403C	1	ATI404-2	1
ATI403F	1	ATI404-3	1
ATI403I	1	ATI4044	1
ATI403M	1	ATI4045	1
ATI403R	1	ATI404-6	1
ATI403V	1	ATI404-7	1
ATI403X	1	ATI404-8	1



ATI404 SERIES

Part Number	Description	D
ATI404-1	Pilot, Bayonet Locking Type, 6" OAL	3/32
ATI404-2	Pilot, Bayonet Locking Type, 6" OAL	1/8
ATI404-3	Pilot, Bayonet Locking Type, 6" OAL	5/32
ATI4044	Pilot, Bayonet Locking Type, 6" OAL	3/16
ATI4045	Pilot, Bayonet Locking Type, 6" OAL	1/4
ATI404-6	Pilot, Bayonet Locking Type, 6" OAL	5/16
ATI404-7	Pilot, Bayonet Locking Type, 6" OAL	3/8
ATI404-8	Pilot, Bayonet Locking Type, 6" OAL	1/2

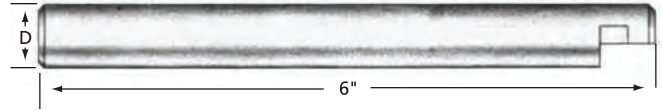

STRAIGHT SHANK COUNTERSINK CUTTER

ATI408 SERIES

Specifically designed for countersinking. This cutter has three straight flutes accurately sharpened to prevent chatter.

Part Number	D	S	Angle
ATI408A-2	1/4	3/16	82°
ATI408A-4	1/4	3/16	100°
ATI408B-2	5/16	1/4	82°
ATI408B-4	5/16	1/4	100°
ATI408C-2	3/8	1/4	82°
ATI408C-4	3/8	1/4	100°
ATI408D-2	7/16	1/4	82°
ATI408D-4	7/16	1/4	100°
ATI408E-2	1/2	1/4	82°
ATI408E-4	1/2	1/4	100°
ATI408F-2	5/8	3/8	82°
ATI408F-4	5/8	3/8	100°
ATI408G-2	3/4	3/8	82°
ATI408G-4	3/4	3/8	100°
ATI408H-2	1	3/8	82°
ATI408H-4	1	3/8	100°

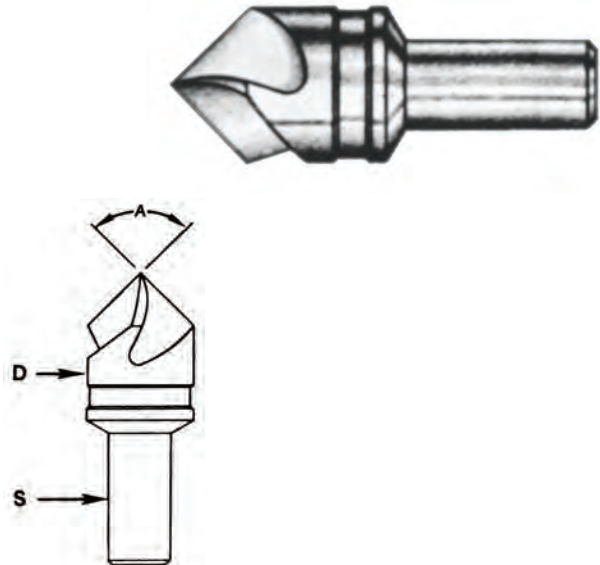

6-FLUTE COUNTERSINK CUTTER, STRAIGHT SHANK

Part Number	Body Diameter	Shank Diameter	Angle
ATI408AZ6F3	1/4	3/16	90°
ATI408AZ6F4	1/4	3/16	100°
ATI408CA6F0	3/8	1/4	60°
ATI408CA6F4	3/8	1/4	100°
ATI408CB6F0	3/8	5/16	60°
ATI408EC6F4	1/2	3/8	100°
ATI408FC6F-4	9/16	3/8	100°
ATI408GC6F0	5/8	3/8	60°
ATI408GC6F3	5/8	3/8	90°
ATI408GC6F4	5/8	3/8	100°

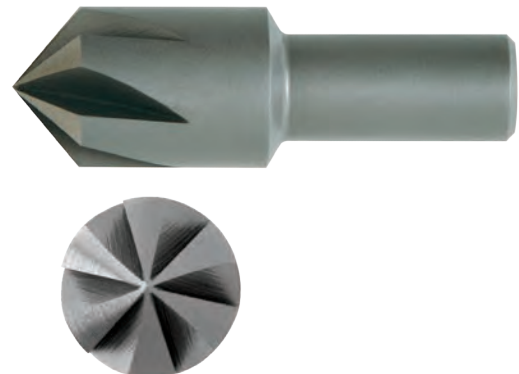

CUTTING TOOLS AND MICROSTOPS

STOP COUNTERSINK CUTTERS



ATI418 SERIES, 1/4"-28 THREADS

Used with ATI442S1 microstop

Three straight flute replaceable pilot cutters with female thread. These cutters are designed with extra deep flute to permit resharpenering and radial clearance to assure fast smooth cutting. Other cutter angles available upon special request.



Part Number	Cutter Diameter	Pilot Hole	Angle
ATI418A-4	1/4	.086	100°
ATI418B-4	5/16	.086	100°
ATI418C-4	3/8	.086	100°
ATI418D-4	7/16	.086	100°
ATI418E4	1/2	.086	100°
ATI418F4	9/16	.086	100°
ATI418G4	5/8	.086	100°

For replaceable pilots, refer to ATI416 Series.

PILOTS

ATI416 SERIES

To maintain concentricity and prevent breakage, an undercut is provided to permit head-to-seat on cutter angle.



Part Number	D		
ATI416-2	#40	ATI416-57	1/8
ATI416-12	#30	ATI416-59	5/32
ATI416-21	#21	ATI416-61	3/16
ATI416-31	#11	ATI416-63	7/32
ATI416-32	#10	ATI416-65	1/4
ATI416-56	3/32	ATI416-69	5/16

Used with ATI418 Series cutter.

CHATTERLESS COUNTERSINK CUTTER

ATI463 SERIES, 1/4"-28 THREADS

These precision cutters are the ultimate in chatterless countersinking. The minimum cutter diameter has been calculated to eliminate skin damage and the undercut on the flutes provides ease in chip removal. Made of M42 material for stainless steel or titanium.

Part Number	Body Diameter	Pilot Diameter	Angle	AN426 Rivet Size Ref.
ATI463145065	.145	.065	100°	1/16
ATI463210096	.210	.096	100°	3/32
ATI463256126	.256	.1265	100°	1/8
ATI463317157	.317	.157	100°	5/32
ATI463385191	.385	.1915	100°	3/16
ATI463507247	.507	.247	100°	1/4
ATI463595309	.595	.309	100°	5/16



HOLLOW CUTTERS

ATI493 SERIES, 1/4"-28 THREADED SHANK FOR REMOVING HUCK AND HI-SHEAR FASTENERS

These cutters are designed to fit standard microstops to control their cutting depth. Used to cut away the swaged collar from the fastener so the pin can be easily removed.

Part Number	Dimension "A"	Dimension "B"	Shank	Fastener Type	Size
ATI493C-0	.365	.124	1/4-28	HI-SHEAR	1/8
ATI493C-00	.365	.157	1/4-28	HI-SHEAR	5/32
ATI493C-1	.438	.188	1/4-28	HI-SHEAR	3/16
ATI493C-2	.500	.247	1/4-28	HI-SHEAR	1/4
ATI493C-3	.562	.310	1/4-28	HI-SHEAR	5/16
ATI493D-1	.323	.188	1/4-28	HUCK LOCK BOLT	L6
ATI493D-3	.413	.250	1/4-28	HUCK LOCK BOLT	L8

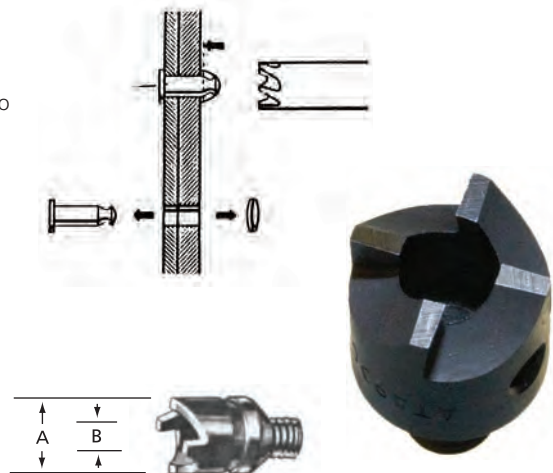

- ATI precision hole saws are manufactured from high-speed tool steel
- Hole saws are heat-treated and ground to precise tolerances
- Hole saw design allows for resharpening of tool
- Use with ATI415 Hole Saw Arbors

FINE TOOTH SERIES

For cutting thin skins and corrugations in aluminum, steel, and other non-ferrous material. The hole saw can be resharpened many times and is designed for use in a portable power unit or in standard machine tools.



ATI413 SERIES

Part Number	Diameter	Thread
ATI413-1	3/8	5/16-24
ATI413-1X	13/32	5/16-24
ATI413-2	7/16	5/16-24
ATI4132X	15/32	5/16-24
ATI413-3	1/2	5/16-24
ATI413-3X	17/32	5/16-24
ATI413-4	9/16	5/16-24
ATI413-4X	19/32	5/16-24
ATI413-5	5/8	5/16-24
ATI4135X	21/32	5/16-24
ATI4136	11/16	5/16-24
ATI413-6X	23/32	5/16-24
ATI413-7	3/4	5/16-24
ATI4137X	25/32	5/16-24
ATI413-8	13/16	5/16-24
ATI413-8X	27/32	5/16-24
ATI413-9	7/8	5/16-24
ATI4139X	29/32	5/16-24
ATI41310	15/16	5/16-24
ATI41310X	31/32	5/16-24
ATI413-11	1	5/16-24
ATI413-11X	1-1/32	5/16-24
ATI413-12	1-1/16	5/16-24
ATI413-12X	1-3/32	5/16-24
ATI413-13	1-1/8	5/16-24
ATI413-13X	1-5/32	5/16-24
ATI413-14	1-3/16	5/16-24
ATI413-14X	1-7/32	5/16-24
ATI413-15	1-1/4	5/16-24
ATI413-15X	1-9/32	5/16-24
ATI413-16	1-5/16	5/16-24
ATI413-16X	1-11/32	5/16-24
ATI41317	1-3/8	5/16-24
ATI413-17X	1-13/32	5/16-24
ATI413-18	1-7/16	5/16-24
ATI413-18X	1-15/32	5/16-24
ATI41319	1-1/2	1/2-20
ATI413-19X	1-17/32	1/2-20
ATI413-20	1-9/16	1/2-20
ATI413-20X	1-19/32	1/2-20
ATI413-21	1-5/8	1/2-20
ATI413-21X	1-21/32	1/2-20
ATI413-22	1-11/16	1/2-20
ATI413-22X	1-23/32	1/2-20

Part Number	Diameter	Thread
ATI41323	1-3/4	1/2-20
ATI413-23X	1-25/32	1/2-20
ATI41324	1-13/16	1/2-20
ATI413-24X	1-27/32	1/2-20
ATI413-25	1-7/8	1/2-20
ATI413-25X	1-29/32	1/2-20
ATI413-26	1-15/16	1/2-20
ATI413-26X	1-31/32	1/2-20
ATI413-27	2	1/2-20
ATI413-27X	2-1/32	1/2-20
ATI413-28	2-1/16	1/2-20
ATI413-28X	2-3/32	1/2-20
ATI413-29	2-1/8	1/2-20
ATI413-29X	2-5/32	1/2-20
ATI41330	2-3/16	1/2-20
ATI413-30X	2-7/32	1/2-20
ATI413-31	2-1/4	1/2-20
ATI413-31X	2-9/32	1/2-20
ATI413-32	2-5/16	1/2-20
ATI413-32X	2-11/32	1/2-20
ATI413-33	2-3/8	1/2-20
ATI413-33X	2-13/32	1/2-20
ATI413-34	2-7/16	1/2-20
ATI413-34X	2-15/32	1/2-20
ATI413-35	2-1/2	1/2-20
ATI413-35X	2-17/32	1/2-20
ATI413-36	2-9/16	1/2-20
ATI413-36X	2-19/32	1/2-20
ATI413-37	2-5/8	1/2-20
ATI413-37X	2-21/32	1/2-20
ATI413-38	2-11/16	1/2-20
ATI413-38X	2-23/32	1/2-20
ATI413-39	2-3/4	1/2-20
ATI413-39X	2-25/32	1/2-20
ATI413-40	2-13/16	1/2-20
ATI413-40X	2-27/32	1/2-20
ATI413-41	2-7/8	1/2-20
ATI413-41X	2-29/32	1/2-20
ATI413-42	2-15/16	1/2-20
ATI413-42X	2-31/32	1/2-20
ATI413-43	3	1/2-20
ATI413-43X	3-1/32	1/2-20
ATI413-44	3-1/16	1/2-20
ATI413-44X	3-3/32	1/2-20

Part Number	Diameter	Thread
ATI413-45	3-1/8	1/2-20
ATI413-45X	3-5/32	1/2-20
ATI413-46	3-3/16	1/2-20
ATI413-46X	3-7/32	1/2-20
ATI413-47	3-1/4	1/2-20
ATI413-47X	3-9/32	1/2-20
ATI413-48	3-5/16	1/2-20
ATI413-48X	3-11/32	1/2-20
ATI413-49	3-3/8	1/2-20
ATI413-49X	3-13/32	1/2-20
ATI413-50	3-7/16	1/2-20
ATI413-50X	3-15/32	1/2-20
ATI413-51	3-1/2	1/2-20
ATI413-51X	3-17/32	1/2-20
ATI413-52	3-9/16	1/2-20
ATI413-52X	3-19/32	1/2-20
ATI413-53	3-5/8	1/2-20
ATI413-53X	3-21/32	1/2-20
ATI413-54	3-11/16	1/2-20
ATI413-54X	3-23/32	1/2-20
ATI413-55	3-3/4	1/2-20
ATI413-55X	3-25/32	1/2-20
ATI41356	3-13/16	1/2-20
ATI413-56X	3-27/32	1/2-20
ATI413-57	3-7/8	1/2-20
ATI413-57X	3-29/32	1/2-20
ATI413-58	3-15/16	1/2-20
ATI413-58X	3-31/32	1/2-20
ATI413-59	4	1/2-20



SAFETY PRECAUTION: Read and follow all safety and operating instructions.
WARNING: Face & eye protection must be worn while operating power tools, per ANSI B186.1

CUTTING TOOLS AND MICROSTOPS

HOLE SAWS



COARSE TOOTH SERIES

This tooth configuration is designed to effect fast cutting of aluminum and steel. When the correct speed and feed is used, this hole saw will cut close tolerance holes even in Titanium.



ATI474 SERIES

Part Number	Diameter	Thread
ATI474-1	3/8	5/16-24
ATI474-1X	13/32	5/16-24
ATI474-2	7/16	5/16-24
ATI474-2X	15/32	5/16-24
ATI474-3	1/2	5/16-24
ATI4743X	17/32	5/16-24
ATI474-4	9/16	5/16-24
ATI474-4X	19/32	5/16-24
ATI474-5	5/8	5/16-24
ATI474-5X	21/32	5/16-24
ATI474-6	11/16	5/16-24
ATI4746X	23/32	5/16-24
ATI474-7	3/4	5/16-24
ATI474-7X	25/32	5/16-24
ATI474-8	13/16	5/16-24
ATI474-8X	27/32	5/16-24
ATI474-9	7/8	5/16-24
ATI4749X	29/32	5/16-24
ATI474-10	15/16	5/16-24
ATI474-10X	31/32	5/16-24
ATI474-11	1	5/16-24
ATI47411X	1-1/32	5/16-24
ATI474-12	1-1/16	5/16-24
ATI47412X	1-3/32	5/16-24
ATI474-13	1-1/8	5/16-24
ATI47413X	1-5/32	5/16-24
ATI474-14	1-3/16	5/16-24
ATI47414X	1-7/32	5/16-24
ATI474-15	1-1/4	5/16-24
ATI47415X	1-9/32	1/2-20
ATI474-16	1-5/16	1/2-20
ATI47416X	1-11/32	1/2-20
ATI474-17	1-3/8	1/2-20
ATI474-17X	1-13/32	1/2-20
ATI474-18	1-7/16	1/2-20
ATI474-18X	1-15/32	1/2-20
ATI474-19	1-1/2	1/2-20
ATI474-19X	1-17/32	1/2-20
ATI474-20	1-9/16	1/2-20
ATI47420X	1-19/32	1/2-20
ATI474-21	1-5/8	1/2-20
ATI47421X	1-21/32	1/2-20
ATI474-22	1-11/16	1/2-20
ATI47422X	1-23/32	1/2-20
ATI474-23	1-3/4	1/2-20
ATI47423X	1-25/32	1/2-20
ATI474-24	1-13/16	1/2-20
ATI474-24X	1-27/32	1/2-20

Part Number	Diameter	Thread
ATI474-25	1-7/8	1/2-20
ATI47425X	1-29/32	1/2-20
ATI474-26	1-15/16	1/2-20
ATI474-26X	1-31/32	1/2-20
ATI474-27	2	1/2-20
ATI474-27X	2-1/32	1/2-20
ATI474-28	2-1/16	1/2-20
ATI474-28X	2-3/32	1/2-20
ATI474-29	2-1/8	1/2-20
ATI474-29X	2-5/32	1/2-20
ATI474-30	2-3/16	1/2-20
ATI474-30X	2-7/32	1/2-20
ATI474-31	2-1/4	1/2-20
ATI47431X	2-9/32	1/2-20
ATI474-32	2-5/16	1/2-20
ATI474-32X	2-11/32	1/2-20
ATI474-33	2-3/8	1/2-20
ATI474-33X	2-13/32	1/2-20
ATI47434	2-7/16	1/2-20
ATI474-34X	2-15/32	1/2-20
ATI474-35	2-1/2	1/2-20
ATI474-35X	2-17/32	1/2-20
ATI47436	2-9/16	1/2-20
ATI47436X	2-19/32	1/2-20
ATI47437	2-5/8	1/2-20
ATI474-37X	2-21/32	1/2-20
ATI474-38	2-11/16	1/2-20
ATI474-38X	2-23/32	1/2-20
ATI474-39	2-3/4	1/2-20
ATI474-39X	2-25/32	1/2-20
ATI474-40	2-13/16	1/2-20
ATI474-40X	2-27/32	1/2-20
ATI474-41	2-7/8	1/2-20
ATI474-41X	2-29/32	1/2-20
ATI474-42	2-15/16	1/2-20
ATI474-42X	2-31/32	1/2-20
ATI474-43	3	1/2-20
ATI47443X	3-1/32	1/2-20
ATI47444	3-1/16	1/2-20
ATI474-44X	3-3/32	1/2-20
ATI47445	3-1/8	1/2-20
ATI47445X	3-5/32	1/2-20
ATI47446	3-3/16	1/2-20
ATI474-46X	3-7/32	1/2-20
ATI474-47	3-1/4	1/2-20
ATI474-47X	3-9/32	1/2-20
ATI474-48	3-5/16	1/2-20
ATI474-48X	3-11/32	1/2-20

Part Number	Diameter	Thread
ATI47449	3-3/8	1/2-20
ATI474-49X	3-13/32	1/2-20
ATI474-50	3-7/16	1/2-20
ATI474-50X	3-15/32	1/2-20
ATI474-51	3-1/2	1/2-20
ATI474-51X	3-17/32	1/2-20
ATI474-52	3-9/16	1/2-20
ATI474-52X	3-19/32	1/2-20
ATI474-53	3-5/8	1/2-20
ATI474-53X	3-21/32	1/2-20
ATI47454	3-11/16	1/2-20
ATI474-54X	3-23/32	1/2-20
ATI474-55	3-3/4	1/2-20
ATI474-55X	3-25/32	1/2-20
ATI47456	3-13/16	1/2-20
ATI474-56X	3-27/32	1/2-20
ATI474-57	3-7/8	1/2-20
ATI474-57X	3-29/32	1/2-20
ATI474-58	3-15/16	1/2-20
ATI474-58X	3-31/32	1/2-20
ATI474-59	4	1/2-20

HOLE SAW ARBORS

- Pilot and shank are ground to ensure tight concentricity
- Use with ATI413 and ATI474 hole saws



ATI415-1

Part Number	Shank Diameter	Pilot Diameter	Thread
ATI415-0	1/4	3/16	5/16-24
ATI415-1	1/4	1/4	5/16-24
ATI415-2	1/2	1/4	1/2-20
ATI415-3	1/2	3/8	1/2-20
ATI415-10	1/4	1/4	1/2-20
ATI415-5	1/4" 3CF	1/4	5/16-24



SAFETY PRECAUTION: Read and follow all safety and operating instructions.
WARNING: Face & eye protection must be worn while operating power tools, per ANSI B186.1

- Aircraft style, straight shank counterbores are used to cut flat areas or recesses for bolt heads and nuts
- Use with ATI489 replaceable counterbore pilots
- A set screw ensures pilot stays in the counterbore
- Standard counterbores have no corner radius

Note: Corner radius available upon special order.

Part Number	Diameter	Pilot Hole Diameter	Shank Diameter
ATI488C-0	3/16	3/32	1/4
ATI488C-1	1/4	3/32	1/4
ATI488C-2	9/32	3/32	1/4
ATI488C-3	5/16	3/32	1/4
ATI488C-4	11/32	3/32	1/4
ATI488C-5	3/8	3/32	1/4
ATI488C-6	13/32	1/8	1/4
ATI488C-7	7/16	1/8	1/4
ATI488C-8	15/32	1/8	1/4
ATI488C-9	1/2	1/8	1/4
ATI488C-10	17/32	1/8	1/4
ATI488C-11	9/16	1/8	1/4

Part Number	Diameter	Pilot Hole Diameter	Shank Diameter
ATI488C-12	19/32	1/8	1/4
ATI488C-13	5/8	1/8	1/4
ATI488C-14	21/32	3/16	1/4
ATI488C-15	11/16	3/16	1/4
ATI488C-16	23/32	3/16	1/4
ATI488C-17	3/4	3/16	1/4
ATI488C-18	25/32	3/16	1/4
ATI488C-19	13/16	3/16	1/4
ATI488C-20	27/32	3/16	1/4
ATI488C-21	7/8	3/16	1/4
ATI488C-22	29/32	3/16	1/4
ATI488C-23	15/16	3/16	1/4
ATI488C-24	31/32	3/16	1/4



Part Number	Diameter	Pilot Hole Diameter	Shank Diameter
ATI488C-25	1	3/16	1/4
ATI488C-26	1 1/16	3/16	3/8
ATI488C-27	1 1/8	3/16	3/8
ATI488C-28	1 3/16	3/16	3/8
ATI488C-29	1 1/4	3/16	3/8
ATI488C-30	1 5/16	3/16	3/8
ATI488C-31	1 3/8	3/16	3/8
ATI488C-32	1 1/2	3/16	3/8

COUNTERBORE PILOTS

- Use these pilots with ATI488C counterbores
- Match the shank diameter of the pilot to the pilot hole diameter of the counterbore

Part Number	Pilot Diameter	Shank Diameter
ATI489A-1	3/32	3/32
ATI489A-2	1/8	3/32
ATI489A-3	5/32	3/32
ATI489A-4	#21	3/32
ATI489A-5	3/16	3/32
ATI489A-6	#10	3/32
ATI489A-7	7/32	3/32
ATI489A-8	1/4	3/32
ATI489A-9	F	3/32
ATI489A-10	9/32	3/32
ATI489A-11	5/16	3/32

Part Number	Pilot Diameter	Shank Diameter
ATI489B-2	1/8	1/8
ATI489B-3	5/32	1/8
ATI489B-4	#21	1/8
ATI489B-5	3/16	1/8
ATI489B-6	#10	1/8
ATI489B-7	7/32	1/8
ATI489B-8	1/4	1/8
ATI489B-9	F	1/8
ATI489B-10	9/32	1/8
ATI489B-11	5/16	1/8
ATI489B-12	11/32	1/8
ATI489B-13	3/8	1/8
ATI489B-14	13/32	1/8
ATI489B-15	7/16	1/8
ATI489B-16	15/32	1/8
ATI489B-17	1/2	1/8

Part Number	Pilot Diameter	Shank Diameter
ATI489C-5	3/16	3/16
ATI489C-6	#10	3/16
ATI489C-7	7/32	3/16
ATI489C-8	1/4	3/16
ATI489C-9	F	3/16
ATI489C-10	9/32	3/16
ATI489C-11	5/16	3/16
ATI489C-12	11/32	3/16
ATI489C-13	3/8	3/16
ATI489C-14	13/32	3/16
ATI489C-15	7/16	3/16
ATI489C-16	15/32	3/16
ATI489C-17	1/2	3/16
ATI489C-18	17/32	3/16
ATI489C-19	9/16	3/16
ATI489C-20	19/32	3/16
ATI489C-21	5/8	3/16
ATI489C-22	21/32	3/16
ATI489C-23	11/16	3/16
ATI489C-24	23/32	3/16
ATI489C-25	3/4	3/16



COUNTERBORE EXTENSION

Counterbore extensions are precision ground to insure concentricity. Used for counterboring in recesses or tight access areas where a longer shank is required.

Part Number	Shank Diameter	"L"
ATI470A-1	1/4"	4"
ATI470A-2	1/4"	6"



SAFETY PRECAUTION: Read and follow all safety and operating instructions.
WARNING: Face & eye protection must be worn while operating power tools, per ANSI B186.1

ATI429SXC

- 3/4" Cutter Capacity
- .0005" Depth Adjustment
- Sioux 1.0 HP 20,000 RPM Power Unit
- Comfort Grip
- Includes ATI429A-4 Skirt



MICRO MILLER CUTTERS AND SKIRTS

ATI429 SERIES

A carbide insert cutter to ensure a hard cutting edge and precision ground to produce a chatter-free cut.

Part Number (Cutter)	Part Number (Skirt)	Diameter
ATI429B-0	ATI429A-1	1/4"
ATI429B-1	ATI429A-1	5/16"
ATI429B2	ATI429A-2	3/8"
ATI429B-3	ATI429A-3	7/16"
ATI429B-4	ATI429A-4	1/2"
ATI429B-5	ATI429A-5	9/16"
ATI429B-6	ATI429A-6	5/8"
ATI429B-7	ATI429A-7	3/4"



RIVET SHAVER KIT

ATI590L

- Includes ATI429SXC Rivet Shaver
- Carbide cutters and skirts for 5/16", 3/8", 7/16", 1/2", 9/16", 5/8" AND 3/4" rivet heads
- Kit box with cutouts provides protection and quick identification of missing components



HI-LOK® TOOLS AND ACCESSORIES

Hi-Lok® Fasteners are the most commonly used lightweight, tamperproof fasteners in the aviation industry. A registered trademark of Hi-Shear Corp, Hi-Lok® fasteners' unique advantages are two-fold. First, Hi-Lok® fasteners yield very consistent clamp force when properly installed, a critical requirement when securing aviation panels. Second, the Hi-Lok® fastener's "frangible" collar shears off upon reaching the required torque, yielding a tamperproof mechanical connection. Hi-Lok® fasteners are most often used in aviation wing assemblies.

ATI offers an extensive line of installation and removal tools to support this product category. Constant refinement of our original designs has resulted in a line of hand tools offering maximum efficiency and trouble-free use. This has been accomplished by ATI's designers and field representatives working closely with aircraft manufacturers to solve production problems.

HI-LOK® INSTALLATION



Installing the Hi-Lok® fastener with the "Roller Clutch" wrench.

Hi-Lok® fasteners completely installed.

HI-LOK® REMOVAL

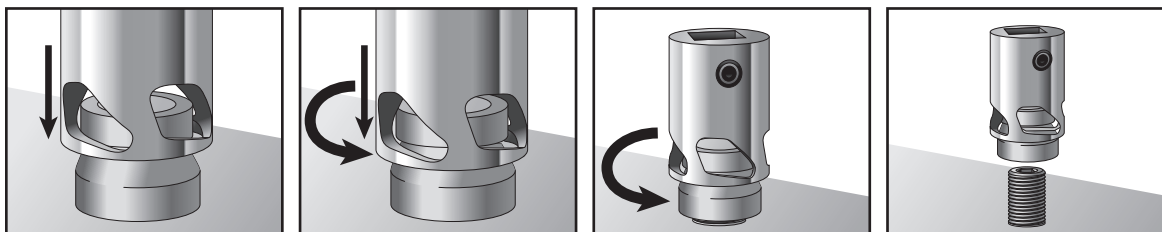

HI-LOK® REVERSIBLE RATCHET WRENCH, 1/4" AND 3/8" DRIVE

Part Number	Description
ATI3594	1/4" Ratchet, 72 tooth, dual pawl, reversing
ATI3595	3/8" Ratchet, 72 tooth, dual pawl, reversing

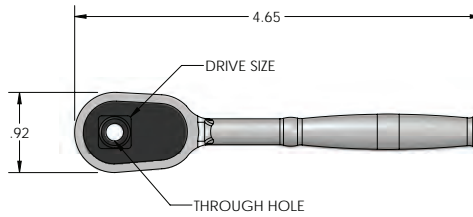

HI-LOK® 6-POINT SOCKETS

Chrome-plated with set screw to secure socket to ratchet.

Part Number	Drive	Hex Size
ATI3596-.19	1/4"	3/16"
ATI3596-.22	1/4"	7/32"
ATI3596-.25	1/4"	1/4"
ATI3596-.28	1/4"	9/32"
ATI3596-.31	1/4"	5/16"
ATI3596-.34	1/4"	11/32"
ATI3596-.38	1/4"	3/8"
ATI3597-.38	3/8"	3/8"
ATI3597-.44	3/8"	7/16"
ATI3597-.50	3/8"	1/2"



ATI3596-.31



ATI3597-.38

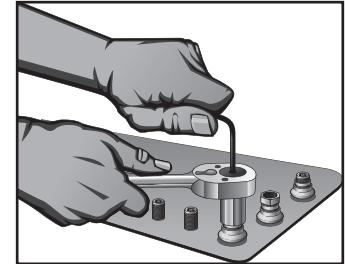

HI-LOK® RATCHET EXTENSIONS

For use with ATI3594 and ATI3595 ratchets and all sockets listed in above table.

Part Number	Drive	Length
ATI3594-2X	1/4"	2"
ATI3594-4X	1/4"	4"
ATI3597-3X	3/8"	3"

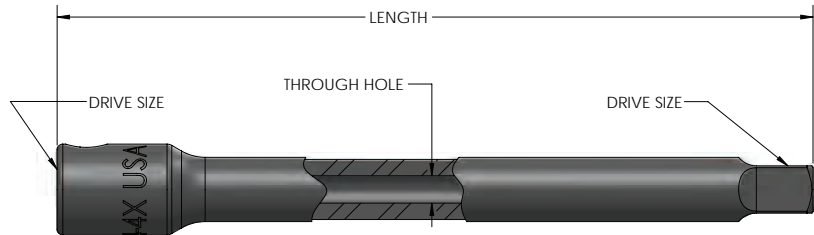

HI-LOK® INSTALLATION KITS

ATI3594K Frangible Collar Installation Kit

Kit for installing frangible collar fasteners, including Hi-Lok® and Hi-Lite®.



ATI3594K

Kit includes:

1	ATI3594	1	ATI3596-.31
1	ATI3596-.19	1	ATI3596-.34
1	ATI3596-.22	1	ATI3596-.38
1	ATI3596-.25	1	ATI3594-2X
1	ATI3596-.28	1	ATI3594-4X
1	Hex Wrench	2	T-Hex Wrenches

ATI3600K Comprehensive Frangible Collar Installation Kit

Comprehensive kit for installing frangible collar fasteners, including Hi-Lok® and Hi-Lite®.



ATI3600K

Kit includes:

1	ATI3594	1	ATI3595
1	ATI3596-.19	1	ATI3596-.34
1	ATI3596-.22	1	ATI3596-.38
1	ATI3596-.25	1	ATI3597-.38
1	ATI3596-.28	1	ATI3597-.44
1	ATI3596-.31	1	ATI3597-.50
1	ATI3594-2X	1	ATI3597-3X
1	Hex Wrench	4	T-Hex Wrenches

- Smooth instantaneous engagement
- Good for limited access areas with limited handle rotation



ATI3539



ATI3539IT38

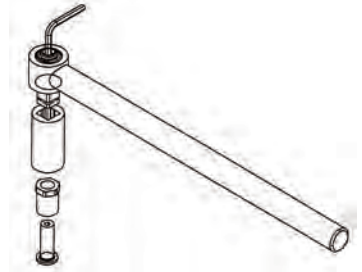

Part Number	Function	Drive	Length	Finish	(ATISK3539A5)	(ATISK3539A8)
ATI3539IT14	Installation	1/4" Hex Socket	3"	Black Oxide	X	X
ATISK3539	Installation	1/4" Square	3"	Black Oxide	X	X
ATISK3539L	Installation	1/4" Square	6"	Black Oxide		
ATI3539I1132	Installation	11/32" Hex Socket	3"	Black Oxide	X	X
ATI3539IT38	Installation	3/8" Hex Socket	3"	Black Oxide		X
ATI3539IT516	Installation	5/16" Hex Socket	3"	Black Oxide	X	X
ATI3539IT716	Installation	7/16" Hex Socket	3"	Black Oxide		X
ATI3539IT732	Installation	7/32" Hex Socket	3"	Black Oxide	X	X
ATISK3539IT9	Installation	9/32" Hex Socket	3"	Black Oxide		
ATISK3539B	Installation	1/4" Square	3"	Zinc		
ATISK3539BL	Installation	1/4" Square	6"	Zinc		
ATISK3539LR	Removal	1/4" Square	6"	Black Oxide		
ATISK3539R	Removal	1/4" Square	3"	Black Oxide		X

HI-LOK® ROLLER CLUTCH WRENCH KITS

ATISK3539A5 Roller Clutch Wrench Kit, 5-PC



Kit includes:

1	ATI2979U	1	ATI3539IT14
1	ATISK3539	1	ATI3539I1132
1	ATI3539IT732	1	ATI3539IT516

ATISK3539A8 Roller Clutch Wrench Kit, 8-PC



Kit includes:

1	ATI2979U	1	ATI3539I1132
1	ATISK3539	1	ATI3539IT516
1	ATISK3539R	1	ATI3539IT38
1	ATI3539IT732	1	ATI3539IT716
1	ATI3539IT14		

ATISK3539LPR Roller Clutch Wrench Kit

This Roller Clutch Wrench Kit consists of two clutch-driven handles, seven insertion tools and three hex wrenches. The sockets and square drive can be inserted in either side of the two-way handle, providing both insertion and removal capabilities. The operator simply removes the socket from one end, and inserts it into the other, to reverse the installation process. These shallow sockets extend 1/4" beyond the thickness of the handle. Assembled, the working end of the tool measures a mere 3/4", allowing maximum close-quarter flexibility.



SAFETY PRECAUTION: Read and follow all safety and operating instructions.
WARNING: Face & eye protection must be worn while operating power tools, per ANSI B186.1

HI-LOK® TOOLS AND ACCESSORIES

NEW FRANGIBLE COLLAR REMOVAL SOCKETS



ATI3581 SERIES

- Design features six-start, left-hand internal threads
- Made from hardened tool steel for long lasting wear and black oxide finish
- Sockets come with female square drive and external hex drive for use with hand or air ratchet, or ratcheting combo wrench
- For use on aluminum, stainless steel, and titanium collars



FRANGIBLE COLLAR REMOVAL SOCKET KIT ATI3581K

Comprehensive kit for removing Hi-Lok®, Hi-Lite®, and Eddie Bolt® collars. Kit includes 1 each of the items below plus applicable hex wrenches.

Part Number	Collar Size	SQ DR	EXT HEX	Description
*ATI3581-5	5/32"	1/4"	7/16"	Removes 5/32" Hi-Lok®, Hi-Lite®, and Eddie Bolt® collars
*ATI3581-6	3/16"	1/4"	7/16"	Removes 3/16" Hi-Lok®, Hi-Lite®, and Eddie Bolt® collars
*ATI3581-8	1/4"	1/4"	7/16"	Removes 1/4" Hi-Lok®, Hi-Lite®, and Eddie Bolt® collars
*ATI3581-10	5/16"	1/4"	7/16"	Removes 5/16" Hi-Lok®, Hi-Lite®, and Eddie Bolt® collars
ATI3581-12	3/8"	3/8"	3/4"	Removes 3/8" Hi-Lok®, Hi-Lite®, and Eddie Bolt® collars
ATI3581-14	7/16"	3/8"	3/4"	Removes 7/16" Hi-Lok®, Hi-Lite®, and Eddie Bolt® collars
ATI3581-16	1/2"	3/8"	3/4"	Removes 1/2" Hi-Lok®, Hi-Lite®, and Eddie Bolt® collars
ATI3581-18	9/16"	3/8"	3/4"	Removes 9/16" Hi-Lok®, Hi-Lite®, and Eddie Bolt® collars
ATI3581-20	5/8"	3/8"	3/4"	Removes 5/8" Hi-Lok®, Hi-Lite®, and Eddie Bolt® collars
ATI3581-4PC	Consists of (*) items above on a socket rail			

ATI3594	ATI3581-8
ATI3595	ATI3581-10
ATI2979U	ATI3581-12
1214RC	ATI3594-2X
ATI3581-5	ATI3594-4X
ATI3581-6	

HI-LOK® REMOVAL TOOLS

HI-LOK® REMOVAL PLIERS ATI2979U

Serrated-jaw pattern for removal of all aluminum frangible collars. Comfort grip handles. Easy access into tight areas.

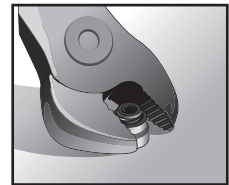

FRANGIBLE COLLAR REMOVAL SOCKETS ATI3585 SERIES

- New Patent-Pending design immediately engages collars with minimal downward force
- Design allows for easy removal of collars from socket after removal
- Sockets feature 1/4" drive and a set screw holds the socket in place on ratchet
- Removes most collars such as Hi-Lok®, Hi-Lite®, Eddie Bolt® and HUCK threaded collar systems, including stainless steel and aluminum
- Versatility: One ATI3585 removal socket can accommodate multiple fastener sizes
- Compact size enables removal in the tightest access areas



Part Number	Pin Size	Description
ATI3585-5B	5/32"	Removes most 5/32" Hi-Lok® and Hi-Lite® collars, aluminum and stainless steel
ATI3585-6A	3/16"	Removes most 3/16" Hi-Lok® and Hi-Lite® collars, stainless steel material
ATI3585-6B	3/16"	Removes most 3/16" Hi-Lok® and Hi-Lite® collars, aluminum material
ATI3585-8A	1/4"	Removes most 1/4" Hi-Lite® collars, aluminum and stainless steel material
ATI3585-8B	1/4"	Removes most 1/4" Hi-Lok® collars, stainless steel material
ATI3585-8C	1/4"	Removes most 1/4" Hi-Lok® collars, aluminum material

FRANGIBLE COLLAR REMOVAL SOCKET SET WITH RAIL ATI3585-6PC



ATI3585-6PC

6-PC set includes:

ATI3585-5B	ATI3585-8A
ATI3585-6A	ATI3585-8B
ATI3585-6B	ATI3585-8C

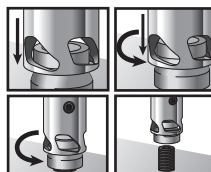

FRANGIBLE COLLAR REMOVAL SOCKET KIT ATI3588K

Comprehensive kit designed for removing various frangible collars including Hi-Lok® and Hi-Lite® fasteners.

Sizes 5/32", 3/16", and 1/4"

Kit includes:

1	ATI3594	1	ATI3585-8C
1	ATI3585-5B	1	ATI2979U
1	ATI3585-6A	1	ATI3594-2X
1	ATI3585-6B	1	ATI3594-4X
1	ATI3585-8A	1	Hex Wrench
1	ATI3585-8B	2	T-Hex Wrench



ATI3588K



SHOP TOOLS

This product section illustrates various tools which were designed to meet specific applications in the fabrication of modern aircraft.



MINA-VACS • SCREW REMOVAL TOOLS • CYLINDRICAL BODY SKIN CLAMP RUNNER • TEMPORARY FASTENERS AND CLAMPS

SHOP TOOLS
PLIERS AND CLAMPS



CANNON PLUG CONNECTOR PLIERS

ATI508K

- Slip-joint handles
- Serrated, replaceable plastic jaws (ATI508K-4)
- Adjustable grip range from 3/4" to 2-1/2" diameter
- Used to tighten or loosen threaded collars on electrical connectors



ATI508K

ATI508KG

ATI508K with high visibility cushioned grips

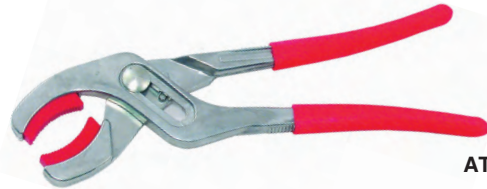

ATI508KG

ATI508K-4

Replaceable pads for ATI508K and ATI508KG



ATI508K-4

SOFT JAW PLIERS, STRAIGHT AND ANGLED

Self-adjusting pliers allow for true one-handed operation. The jaws adjust as quickly as your hand can squeeze, making every job faster and easier. Narrow jaw design allows easy access to the tightest places with the least clearance. Serrated, replaceable plastic jaws are durable and easy to install.

Part Number	Description
ATI509AP8	Cannon plug connector pliers, 30° offset angled head, 1-5/8" capacity, 8" length
ATI509RP8	Cannon plug connector pliers, straight head, 1-5/8" capacity, 8" length
ATI509A-1	Replaceable plastic insert for ATI509AP8 and ATI509RP8



ATI509AP8

CAMLOC PLIERS

ATI044P3

For use with Camloc Fasteners, Stud Series 2000, 2700, and 4002.



ATI044P3

SHEET HOLDER PLIERS

- Forged steel
- Available with ergonomically designed cushioned grips

Part Number	Description
ATI508S	For use with ATI542, ATI543, ATI544, and plier-operated sheet holders and side grip clamps
ATI508SG	ATI508S with high visibility cushioned grips



ATI508S



ATI508SG





AT1542

SPRING TENSION CLAMPS

- U-Clamp, plier operated; 70-pound clamping force
- Designed to use with AT1508S or AT1508SG

Part Number	Material	Material Capacity	Reach
AT1542	Zamak	0-7/16"	2"
AT1542S	Steel	0-7/16"	2"
AT1543	Zamak	1/4"-15/32"	3"
AT1544	Zamak	1/2"-3/4"	3-1/2"

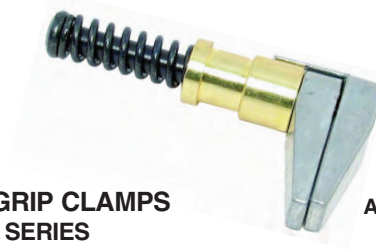

AT1550SG

SIDE-GRIP CLAMPS
AT1550 SERIES

- Plier-operated, spring loaded
- Minimal surface marring
- Spring design prevents over tightening
- 60 pounds clamping force

Part Number	Material Capacity	Reach	OAL
AT1550SG	0-3/4"	1"	2-7/16"
AT1551SG	0-3/4"	1/2"	2-7/16"
AT1552SG	0-1/2"	1"	2-3/16"
AT1553SG	0-1/2"	1/2"	2-3/16"

VICE SLEEVES

Part Number	Description
AT1529	Vice sleeves, molded rubber, 4" jaw sold in pairs
AT1530	Vice sleeves, molded rubber, 4-1/2" jaw sold in pairs

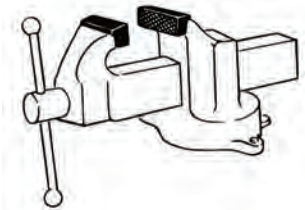
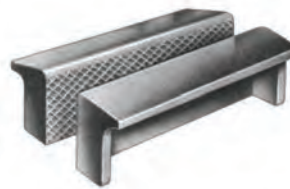

TEMPORARY FASTENERS

PLIER OPERATED TEMPORARY FASTENERS

Part Number	Grip Range	Body Length	Size	For Drill	Color
AT1551M	0-1/4"	1-29/64"	3/32"	#40	ZINC
AT1552M	0-1/4"	1-29/64"	1/8"	#30	COPPER
AT1553M	0-1/4"	1-29/64"	5/32"	#21	BLACK
AT1554M	0-1/4"	1-29/64"	3/16"	#10	BRASS
AT1556M	0-1/4"	1-31/64"	1/4"	1/4"	COPPER
AT1551MHD	0-1/2"	1-7/64"	3/32"	#40	ZINC
AT1552MHD	0-1/2"	1-7/64"	1/8"	#30	COPPER
AT1553MHD	0-1/2"	1-7/64"	5/32"	#21	BLACK
AT1554MHD	0-1/2"	1-7/64"	3/16"	#10	BRASS
AT1556MHD	0-1/2"	1-47/64"	1/4"	1/4"	COPPER

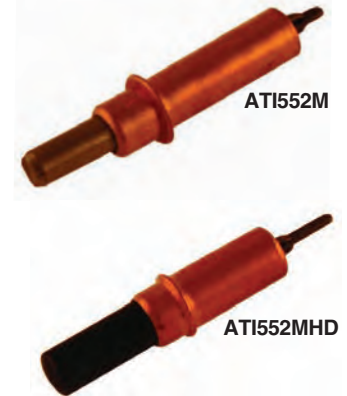
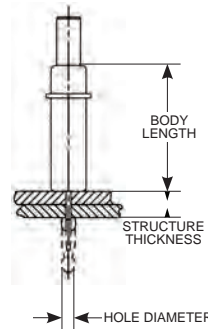

MANUAL OPERATED TEMPORARY FASTENERS, WING NUT

Part Number	Grip Range	Body Length (OAL)	Size	For Drill	Color
AT1551WNX	0-1/2"	2-7/8"	3/32"	#40	ZINC
AT1552WNX	0-1/2"	2-7/8"	1/8"	#30	COPPER
AT1553WNX	0-1/2"	2-7/8"	5/32"	#21	BLACK
AT1554WNX	0-1/2"	2-7/8"	3/16"	#10	BRASS
AT1556WNX	0-1/2"	2-7/8"	1/4"	1/4"	COPPER
AT1551WNXL	0-1"	3-7/8"	3/32"	#40	ZINC
AT1552WNXL	0-1"	3-7/8"	1/8"	#30	COPPER
AT1553WNXL	0-1"	3-7/8"	5/32"	#21	BLACK
AT1554WNXL	0-1"	3-7/8"	3/16"	#10	BRASS
AT1556WNXL	0-1"	3-7/8"	1/4"	1/4"	COPPER

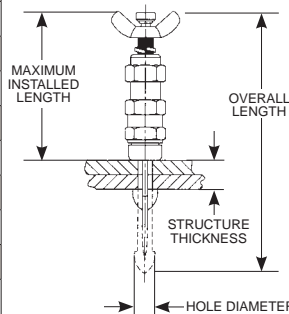

SAFETY PRECAUTION: Read and follow all safety and operating instructions.
WARNING: Face & eye protection must be worn while operating power tools, per ANSI B186.1

SHOP TOOLS
TEMPORARY FASTENERS



POWER OPERATED TEMPORARY FASTENERS, HEX NUT

Part Number	Grip Range	Body Length (OAL)	Size	For Drill	Color
ATI551HNX	0-1/2"	2-7/8"	3/32"	#40	ZINC
ATI552HNX	0-1/2"	2-7/8"	1/8"	#30	COPPER
ATI553HNX	0-1/2"	2-7/8"	5/32"	#21	BLACK
ATI554HNX	0-1/2"	2-7/8"	3/16"	#10	BRASS
ATI556HNX	0-1/2"	2-7/8"	1/4"	1/4"	COPPER
ATI551HNXL	0-1"	3-7/8"	3/32"	#40	ZINC
ATI552HNXL	0-1"	3-7/8"	1/8"	#30	COPPER
ATI553HNXL	0-1"	3-7/8"	5/32"	#21	BLACK
ATI554HNXL	0-1"	3-7/8"	3/16"	#10	BRASS
ATI556HNXL	0-1"	3-7/8"	1/4"	1/4"	COPPER

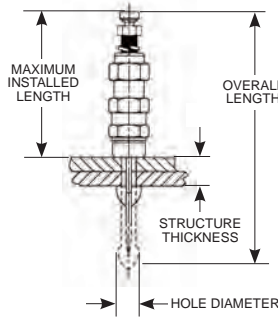

POWER OPERATED TEMPORARY FASTENERS, CYLINDRICAL BODY

Part Number	Part Number W/ Plastic Cap	Body Length (OAL)	Grip Range	Size	For Drill	Color
CBXBF332PC	CBXBF332PC	4-1/32"	0-1/2"	3/32"	#40	ZINC
CBX-BF-1/8	CBXBF18PC	4-1/16"	0-1/2"	1/8"	#30	COPPER
CBX-BF-5/32	CBXBF532PC	4-3/32"	0-1/2"	5/32"	#21	BLACK
CBXBF316	CBXBF316PC	4-1/8"	0-1/2"	3/16"	#10	BRASS
CBX-BF-1/4	CBXBF14PC	4-5/32"	0-1/2"	1/4"	1/4"	COPPER
CBXL-BF-3/32	CBXLB332PC	5-1/32"	0-1"	3/32"	#40	ZINC
CBXL-BF-1/8	CBXLB18PC	5-1/16"	0-1"	1/8"	#30	COPPER
CBXLB532	CBXLB532PC	5-3/32"	0-1"	5/32"	#21	BLACK
CBXL-BF-3/16	CBXLB316PC	5-1/8"	0-1"	3/16"	#10	BRASS
CBXL-BF-1/4	CBXLB14PC	5-5/32"	0-1"	1/4"	1/4"	COPPER

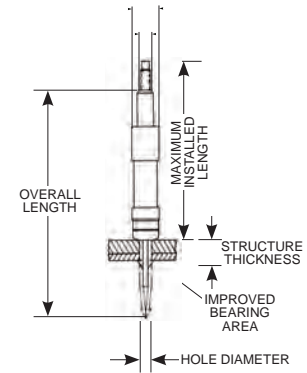

SKIN CLAMP RUNNER, FOR CYLINDRICAL BODY FASTENERS

ATI800FGB

- Heavy duty, lightweight, and compact
- Greater torque in reverse eases removal of installed fastener
- Dual roller clutch carriers for longevity
- Barrel diameter: 1.01"
- Shuttle reverse lever design allows for better clearance
- Air motor stalls at 25 in.-lbs. at 90 psi
- CE Certified

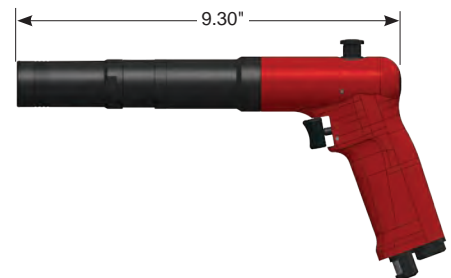

ATI800FGC TORQUE CONTROL CLUTCH

- Heavy duty, lightweight, and compact
- Adjustable clutch for specific torque applications
- Push button rapid reverse with lock position
- Greater torque in reverse eases removal of installed fastener
- Dual roller clutch carriers for longevity
- CE Certified



TORQ-SET™ INSERT BIT 
1/4" HEX DRIVE

Part Number	Size	OAL
ATIT0A1	0"	1"
ATIT1A1	1"	1"
ATIT2A1	2"	1"
ATIT3A1	3"	1"
ATIT4A1	4"	1"
ATIT5A1	5"	1"
ATIT6A1	6"	1"
ATIT8A1	8"	1"
ATIT10A1	10"	1"
ATIT16A1	1/4"	1"

TORQ-SET™ SCREWDRIVERS

This accessory combines both bit and driver for installation of Torq-Set® insert bits. Shock-proof and non-flammable, the handles are deep fluted for grip and turning power. Carried in standard point sizes 4, 6, 8, 10 and 1/4".



Part Number	Point Size	Driver	Driver Length	OAL
ATI268P4	4	1/4" Hex	3-1/8"	7-1/16"
ATI268P6	6	1/4" Hex	4"	7-15/16"
ATI268P8	8	1/4" Hex	4"	7-15/16"
ATI268P10	10	1/4" Hex	4"	7-15/16"
ATI268P-1/4	1/4"	5/16" Hex	6"	10-1/2"

HI-TORQUE® DRIVER
Square Drive Insert Bits

Part Number	Hex Insert	Blade Thickness	Blade Width	Body Diameter	Length
ATIHTS1	1/4"	.049	.274	1/2"	1"
ATIHTS-2	1/4"	.059	.295	1/2"	1"
ATIHTS-3	1/4"	.059	.377	1/2"	1"
ATIHTS3A	3/8"	.059	.377	1/2"	1"
ATIHTS-4	1/4"	.073	.502	1/2"	1"
ATIHTS4A	3/8"	.073	.502	1/2"	1-1/4"
ATIHTS-5	3/8"	.079	.629	3/4"	1-1/4"
ATIHTS6	3/8"	.095	.745	3/4"	1-1/4"



ATIHTS-3

8-SPLINE OCTAGONAL SOCKETS

These sockets are used extensively on P3 Patrol and A-10 Wart Hog maintenance. The Kaynar fastener is also used on Airbus wing sections. High-quality tool steel with nickel-chrome plating.

Part Number	Reference	Description	Fastener Size
ATISK3686-2T	W-603-2	Socket, 8-Spline, Octagonal	#8
ATISK3686-3T	W-603-3	Socket, 8-Spline, Octagonal	#10
ATISK3686-4T	W-603-4	Socket, 8-Spline, Octagonal	1/4"
ATISK3686-5F	W-603-5	Socket, 8-Spline, Octagonal	5/16"
ATISK3686-6F	W-603-6	Socket, 8-Spline, Octagonal	3/8"
ATISK3686-7S	W-603-7	Socket, 8-Spline, Octagonal	7/16"
ATISK3686-8S	W-603-8	Socket, 8-Spline, Octagonal	1/2"
ATISK3686-9S	W-603-9	Socket, 8-Spline, Octagonal	9/16"
ATISK368610S	W-603-10	Socket, 8-Spline, Octagonal	5/8"



SCREW REMOVAL TOOLS

ATI540 SERIES

These tools are useful in removing screws that are corroded and cannot be loosened by conventional methods without skin damage. Designed with a parker taper .401 shank to fit most standard rivet guns and held in place by a retainer spring. Available with 3/8" male drive or 1/4" machined hex bit receptacle.

Part Number	Type	SHANK	OAL
ATI540	3/8" square drive	.401	9"
ATI540S	3/8" square drive	.401	4-1/2"
ATI540BS-5	1/4" hex receptacle	.401	5-1/2"
ATI540BL-7	1/4" hex receptacle	.401	7-1/2"
*ATI540SE-5	1/4" hex bit adaptor, 3/8" square drive		

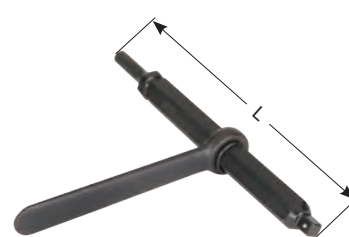

ATI540



ATI540SE-5

*Use with ATI540 or ATI540S



SAFETY PRECAUTION: Read and follow all safety and operating instructions.
WARNING: Face & eye protection must be worn while operating power tools, per ANSI B186.1

SHOP TOOLS

SCREW REMOVAL TOOLS



EL BRUTUS...THE ORIGINAL

This unique assembly removes the most stubborn screws such as Phillips, Tri-Wing, Hi-Torque and more. Heat-treated and plated for long durability. A favorite of both military and airframe technicians.

Part Number	Screw Capacity	Weight	OAL
ATI540-5	#8 to 1/4"	3.2 lbs.	17"
ATI540-7	1/4" to 3/8"	5.4 lbs.	18-3/4"



ATI540-5

MINA-VACS PNEUMATIC

ATI560V plastic Mina-vac pulls up to 5.0 in. Hg static pull.

ATI560M metal Mina-vac pulls up to 4.0 in. Hg static pull.

- 25% stronger vacuum strength than comparable brands
- Built-in chip deflector minimizes bag damage
- Removes objects such as Clecos up to 3/4" diameter from confined spaces
- One-piece housing and metal 1/4" NPT input for improved durability (ATI560V)
- Equipped with an "on" and "off" trigger button that can be locked in the "on" position (ATI560M)

Vacuum Assembly	Housing Material	Extension Hose Part Number	Hose Material	Hose Length (in)	Bag Part Number
ATI560V	PLASTIC				ATI560A-3
ATI560VF12	PLASTIC	ATI560MFE12	FLEXIBLE PLASTIC	12	ATI560A-3
ATI560VF18	PLASTIC	ATI560MFE18	FLEXIBLE PLASTIC	18	ATI560A-3
ATI560VF24	PLASTIC	ATI560MFE24	FLEXIBLE PLASTIC	24	ATI560A-3
ATI560M	ALUMINUM				ATI560A-3
ATI560MF12	ALUMINUM	ATI560MFE12	FLEXIBLE PLASTIC	12	ATI560A-3
ATI560MF18	ALUMINUM	ATI560MFE18	FLEXIBLE PLASTIC	18	ATI560A-3
ATI560MF24	ALUMINUM	ATI560MFE24	FLEXIBLE PLASTIC	24	ATI560A-3
ATI560MF-36	ALUMINUM	ATI560MFE36	FLEXIBLE PLASTIC	36	ATI560A-3
ATI560MHDF18	ALUMINUM	ATI560MFE18	FLEXIBLE PLASTIC	18	ATI560HD3
ATI560MR-12	ALUMINUM	ATI560MRE12	RIGID PLASTIC	12	ATI560A-3
ATI560MR18	ALUMINUM	ATI560MRE18	RIGID PLASTIC	18	ATI560A-3
ATI560MR36	ALUMINUM	ATI560MRE36	RIGID PLASTIC	36	ATI560A-3



ATI560CF18

ATI560MFE18

ATI560MRE12

ATI560V

ATI560M

MINA-VAC ACCESSORIES

Part Number	Description
ATI560CF12	Extension Hose, Flex, 12" OAL. Used with discontinued ATI560C
ATI560CF18	Extension Hose, Flex, 18" OAL. Used with discontinued ATI560C
ATI560CF24	Extension Hose, Flex, 24" OAL. Used with discontinued ATI560C
ATI560CF36	Extension Hose, Flex, 36" OAL. Used with discontinued ATI560C
ATI560A-3	Vacuum Bag, Replacement for use with ATI560V or ATI560M
ATI560HD-3	Vacuum Bag, Heavy Duty. Vinyl Reinforcement
ATI560A-4	Clip for Vacuum Bag
ATI560R10	Extension Tube, Rigid PVC, 12" OAL

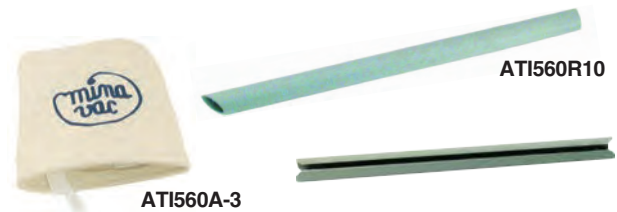

ATI560A-3

ATI560R10

MINA-VAC, HEPA

ATI560MHP METAL MINA-VAC WITH HEPA BAG AND 12" FLEXIBLE PLASTIC HOSE

The NEW ATI560MHP uses the ATI560M aluminum housing for better strength and durability. Comes with ATI560HP-3 HEPA filter bag and adaptor. HEPA bag reduces exposure to cadmium and hexavalent chromium dust. Airtight cap on filter bag insures FOD containment.

Vacuum Assembly	Housing Material	Extension Hose Part Number	Hose Material	Hose Length (in)	Bag Part Number
ATI560MHP	ALUMINUM	ATI560MFE12	FLEXIBLE PLASTIC	12	ATI560HP-3

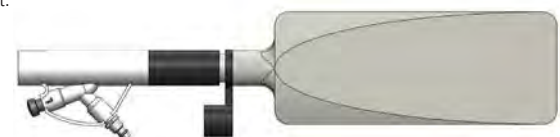

RTW Series

These ratcheting torque wrenches are designed for use on fuel-, hydraulic-, and oxygen-line fittings, where specific torque requirements are mandated. The assembly consists of pre-set "clicker" torque wrenches designed and manufactured by CDI Torque Products, and ratcheting jaws, plates, and adapter manufactured by ATI.

Order by BASIC PART NUMBER-HEX SIZE IN 1/64" INCREMENT- TORQUE REQUIREMENT (IN-LBS)

	Part Number	Description
Ex.	RTW40-190	5/8" Ratcheting Jaws, 190 in. lbs.
Ex.	RTW80-100	1-1/4" Ratcheting Jaws, 100 in. lbs.



FEATURES:

- Torques in both right and left hand directions; automatic reset when force on handle is released
- Torque limiting positive sensory "click" when preset torque is reached
- Smooth knurled steel hand-hold for comfortable, safe grip
- Handle length proportioned to torque range of wrench for minimum user fatigue
- Tamper-proof torque setting for production line use
- Wrench assembly snaps open to accommodate existing installations
- Flank-drive, hardened-steel jaws
- All handle parts are made of alloy steel for maximum life and calibration retention
- Duratorque high duty alloy steel spring for accuracy and long life

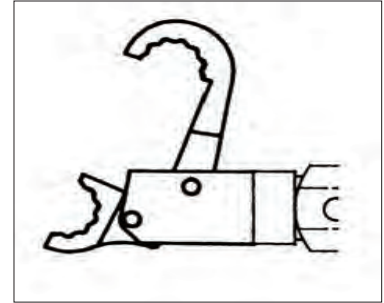

INTERCHANGEABLE RATCHET HEADS



RTWH Series

Order by BASIC PART NUMBER-HEX SIZE IN 1/64" INCREMENT- SHANK SIZE (J OR Y)

Part Number	Description	Part Number	Description
RTWH28J	7/16" Ratchet Head Assembly, J Shank	RTWH64J	1" Ratchet Head Assembly, J Shank
RTWH32J	1/2" Ratchet Head Assembly, J Shank	RTWH64Y	1" Ratchet Head Assembly, Y Shank
RTWH36J	9/16" Ratchet Head Assembly, J Shank	RTWH72Y	1-1/8" Ratchet Head Assembly, Y Shank
RTWH36Y	9/16" Ratchet Head Assembly, Y Shank	RTWH80J	1-1/4" Ratchet Head Assembly, J Shank
RTWH40J	5/8" Ratchet Head Assembly, J Shank	RTWH80Y	1-1/4" Ratchet Head Assembly, Y Shank
RTWH40Y	5/8" Ratchet Head Assembly, Y Shank	RTWH88Y	1-3/8" Ratchet Head Assembly, Y Shank
RTWH44J	11/16" Ratchet Head Assembly, J Shank	RTWH96J	1-1/2" Ratchet Head Assembly, J Shank
RTWH48J	3/4" Ratchet Head Assembly, J Shank	RTWH96Y	1-1/2" Ratchet Head Assembly, Y Shank
RTWH48Y	3/4" Ratchet Head Assembly, Y Shank	RTWH104Y	1-5/8" Ratchet Head Assembly, Y Shank
RTWH52J	13/16" Ratchet Head Assembly, J Shank	RTWH120Y	1-7/8" Ratchet Head Assembly, Y Shank
RTWH56J	7/8" Ratchet Head Assembly, J Shank	RTWH128J	2" Ratchet Head Assembly, J Shank
RTWH56Y	7/8" Ratchet Head Assembly, Y Shank	RTWH128Y	2" Ratchet Head Assembly, Y Shank
RTWH60J	15/16" Ratchet Head Assembly, J Shank	RTWH136Y	2-1/8" Ratchet Head Assembly, Y Shank
RTWH60Y	15/16" Ratchet Head Assembly, Y Shank		

SHOP TOOLS

VALVE CORE REMOVAL TOOL



ATISK3614

- For rapid and safe tire deflation
- Machined aluminum tool threads into valve stem
- Releases and traps the valve core within the tool
- Exhausts the air through ports, away from the technician



ATISK3614

DIGITAL PROTRACTOR

ATIPRO360

The ATIPRO360 Digital Protractor is a revolutionary tool that provides you with an immediate digital indication of level, plumb, and all the angles in between. The machined aluminum frame with integral base plate is a light, rigid, and ultra precise platform. State-of-the-art sensor and microprocessor circuit provides unsurpassed accuracy throughout the protractor's 360° range.

The ATIPRO360 features zero (alternate reference), a hold button to freeze displayed angle, simple calibration requiring no fixture and a one-year warranty.

Note: Calibration certificate not included



CABLE TENSIO METERS

Pacific Scientific



T60

The Pacific Scientific Type T60 is a simple, yet precise instrument designed for use in accurate rigging of airborne control cables. Used extensively worldwide, it has proven its durability under long and continual service. It is suitable for use over a wide range of tension measurements and different cable sizes, and can be used under extreme conditions of heat or cold without affecting the accuracy or readings.

Part Number	Cable Size	Range
T601001C81A	1/16", 3/32", 1/8"	10-200
	5/32", 3/16"	30-300
	7/32", 1/4"	80-200
T601001C91A	1/8", 5/32", 3/16", 7/32", 1/4"	150-400



T5

The Pacific Scientific T5 is a low-cost, highly accurate, precision instrument that gives cable tension readings covering a wide range. No preliminary adjustments required before use. Not affected by heat or cold, one instrument handles many cable sizes. Small size permits entry through small openings.

Part Number	Cable Size	Range
T5200210100	1/16", 3/32", 1/8"	10-100
	5/32", 3/16"	15-150
	7/32", 1/4"	25-150
T5200210400	1/16", 3/32", 1/8"	30-200
	5/32", 3/16"	30-300
	7/32", 1/4"	30-300
T5200411300	1/16", 3/32", 1/8"	10-100
T5800310600	3/16", 7/32", 1/4"	40-600
	5/16"	40-600
T5800210500	1/16", 3/32", 1/8"	30-200
	5/32", 3/16"	30-400
	7/32", 1/4"	30-400
T5800221100	1/16", 3/32", 1/8"	35-350
T5800511000	3/16"	300-1600
	7/32", 1/4"	300-1600
	5/16"	300-1600
T5800810600	1/8", 5/32"	40-600
	3/16"	40-600
	1/4"	40-600



ATISP1001

TURNBUCKLE WRENCH, CABLE RIGGING TOOL ATISP1001

This special cable rigging tool was designed to assist in adjusting turnbuckles on aircraft cable. The tool consists of two clamps joined by a 12" sprocket chain. When clamped to cable-end fittings on each side of the turnbuckle, the cable becomes stationary, allowing free turnbuckle adjustment.

Part Number	Size	Grip
ATISP1001	Light Duty	0 - 1/2"
ATISP1002	Heavy Duty	0 - 5/8"



CABLE SWAGING EQUIPMENT

ATI's Swaging and Pull Test equipment is regarded as the leader in the commercial and military aviation circles. Whether the cable assemblies are swaged within a traditional "tube shop" or making repairs on the flight line, ATI has the equipment and die sets to meet your requirements. Our ATI520JK and ATI520CTK are the most popular portable units for swaging and pull testing terminals on cable sizes 1/16" through 3/16".



ATI offers full service and repair on our swaging equipment and calibration certification on our pull tester units. Please contact ATI customer service for more information.



The ATI520D operates from an air supply of 30 cfm at 90 to 100 psi and 110 vac. A step-down transformer is available for overseas operation.

STATIONARY CABLE SWAGER **ATI520D**

The ATI520D Stationary Swaging machine is a ruggedly constructed unit, weighing approximately 400 pounds and measuring 12" deep by 24" wide by 58" high. The new heavy duty yoke permits rapid installation and removal of dies and incorporates a shock absorbing feature to prevent breakage. The same quick change swaging and cutting dies are used in both portable (ATI520J) and stationary equipment. It is capable of swaging ball-end terminals such as AN663 up to the -6 (3/16 cable size), and sleeve-type terminals through -8 (1/4 cable size).

This tool approaches the capacity of a 50-ton punch-press and is able to swage over 90% of aircraft-type terminals. An outstanding feature of the ATI520D Cable Swager is the automatic swaging time controls. The operator merely sets the timer for the size fitting to be swaged, and the machine automatically stops when the work is completed.

Another feature of the machine is the "terminal clamping action". The machine is equipped with a two-stage foot switch. By depressing the switch to the first stage, the dies come together pneumatically and firmly clamp the terminals. At this point, the operator may make any terminal location adjustment he wishes. The foot switch is then depressed to the second stage and the electrically timed swaging action begins. When swaging time has been completed, the machine turns off and the dies automatically return to the full open position.

Die racks are built into the sides of the machine to accommodate the complete set of swaging and cutting dies. An air filter and lubricator provide dust-free air, plus oil to the power unit. Bolt holes are provided for floor installation.

STATIONARY CABLE SWAGER KIT **ATI520DK**

The ATI520DK Stationary Cable Swager Kit includes the ATI520D Swager, and the 27 pair of swaging and cut-and-trim dies shown with the ATI520JK Portable Cable Swager Kit.

**PORTABLE CABLE SWAGER
ATI520J**



This light weight portable unit is designed to precision-swage cable terminals... even when used by operators with no previous experience. It can be used as a bench unit when mounted on the shock absorbing base, or taken directly to the scene of operation.

The ATI520J Swager, complete with base plate, air hose, and foot control, or any sets of dies, can be ordered separately.

**SWAGE GAUGE
ATI520SG**



"Go" type gauge designed to check all swaged terminals within the capacity of the ATI520D and ATI520J swagers. Included with ATI520JK.

**PORTABLE CABLE SWAGER KIT
ATI520JK**



The Kit is furnished with the ATI520J Swager, ATI520SG Swage Gauge, Felco C7 hand cable cutters, and ATISP1001 Turnbuckle Wrench, and all the dies shown below. The swager is designed to cold-flow the metal of the terminal into the interstices of the cable strands to which it is attached. Controlling factors are that the swaged terminal shall conform to specified dimensions, be free from fatigue fractures, and hold at least to the minimum rated breaking strength of the cable. Dies carried in stock are for standard MS sleeve-type and ball-end terminals. Cut-off and trim dies are manufactured in sizes to cut cable up to 1/4" in diameter without fraying or crushing wire strands, permitting rapid insertion of the terminal over the cable.

ALL SWAGING DIES SOLD IN PAIRS; CUT AND TRIM DIES SOLD INDIVIDUALLY

For use with ATI520D and ATI520J Swagers.

FOR DOUBLE SHANK BALL END TERMINALS

Part Number	Cable Diameter	Terminal Ref.
ATI520CDB-2	1/16"	MS20663-2
ATI520CDB-3	1/32"	MS20663-3
ATI520CDB-4	1/8"	MS20663-4
ATI520CDB-5	5/32"	MS20663-5
ATI520CDB-6	3/16"	MS20663-6



FOR SINGLE SHANK BALL END TERMINALS

Part Number	Cable Diameter	Terminal Ref.
ATI520CSB-2	1/16"	MS20664-2
ATI520CSB-3	1/32"	MS20664-3
ATI520CSB-4	1/8"	MS20664-4
ATI520CSB-5	5/32"	MS20664-5
ATI520CSB-6	3/16"	MS20664-6



FOR PLAIN BALL END TERMINALS

Part Number	Cable Diameter	Terminal Ref.
ATI520CB-2	1/16"	RA2487
ATI520CB-3	1/32"	RA2487
ATI520CB-4	1/8"	RA2487



FOR SLEEVE TYPE TERMINALS

Part Number	Cable Diameter	Terminal Dash No.
ATI520CS-2	1/16"	-2
ATI520CS-3	1/32"	-3
ATI520CS-4	1/8"	-4
ATI520CS-5	5/32"	-5
ATI520CS-6	3/16"	-6
ATI520CS-7	7/32"	-7
ATI520CS-8	1/4"	-8



CABLE CUT-OFF AND TRIM DIES

Part Number (Die)	Cable Diameter	Part Number (Punch)
ATI520CD-2	1/16"	ATI520CP-2
ATI520CD-3	1/32"	ATI520CP-3
ATI520CD-4	1/8"	ATI520CP-4
ATI520CD-5	5/32"	ATI520CP-5
ATI520CD-6	3/16"	ATI520CP-6
ATI520CD-7	7/32"	ATI520CP-7
ATI520CD-8	1/4"	ATI520CP-8



SAFETY PRECAUTION: Read and follow all safety and operating instructions.
WARNING: Face & eye protection must be worn while operating power tools, per ANSI B186.1

SWAGING EQUIPMENT

SWAGED CABLE TERMINAL PULL TESTER



ATI520CT

The ATI520CT Pull Tester is a self-contained hydraulic unit in which the tensile load applied to the cable and terminal assembly is produced by developing pressure in a hydraulic cylinder. The pressure in the cylinder is related to the pounds tension applied to the terminal and cable assembly, and is indicated by a direct-reading pressure gage calibrated in pounds tension. The face of the gage is graduated and indicated by cable size, and the respective 60% rated tensile strength. This terminal tester has the capacity to pull-test sizes and types of terminals which can be swaged by the ATI520J or ATI520D Swagers.



ATI520CTK

The ATI520CTK Portable Cable Pull Tester Kit is used in conjunction with the ATI520D and ATI520J Cable Swagers. It has been designed as a portable unit to enable Field Service Groups, Aircraft Manufacturers and Repair Depots to test swaged terminals.

During testing, the cable is held between two soft copper blocks which have been designed to avoid damage to the cable. The operation of this unit is simple and no experience or training is required to effectively test swaged terminals. The basic unit weighs 24-3/4 pounds, is 5-3/4" wide, 10-1/4" high and 23-1/8" long. It is light and small enough to be carried by one man. This compact size adds to its versatility and allows proof-loading of swaged terminals after the cable has been installed.



ATI520CTK KIT CONSISTS OF THE FOLLOWING:
(NOTE: Jaws are furnished in pairs)

Part Number	Legacy	Item Description / cable diameter
ATI520CT	AT520CT	Pull Tester complete with handle and jaw holder
ATI520CTD2	AT520CTD-2	COPPER JAWS-1/16"
ATI520CTD3	AT520CTD-3	COPPER JAWS-3/32"
ATI520CTD4	AT520CTD-4	COPPER JAWS-1/8"
ATI520CTD-5	AT520CTD-5	COPPER JAWS-5/32"
ATI520CTD6	AT520CTD-6	COPPER JAWS-3/16"
ATI520CTD-7	AT520CTD-7	COPPER JAWS-7/32"
ATI520CTD-8	AT520CTD-8	COPPER JAWS-1/4"
ATI520CTF-5	AT520CTF-5	ADAPTER 5/32" (use with 1/4" Dia Pin)
ATI520CTF6	AT520CTF-6	ADAPTER 3/16" (use with 5/16" Dia Pin)
ATI520CTF7	AT520CTF-7	ADAPTER 7/32" (use with 5/16" Dia Pin)
ATI520CTF-8	AT520CTF-8	ADAPTER 1/4" (use with 3/8" Dia Pin)
ATI520CTP-1	AT520CTP-1	3/16" DIAMETER PIN W/KNURLED HEAD
ATI520CTP2	AT520CTP-2	1/4" DIAMETER PIN W/KNURLED HEAD
ATI520CTP3	AT520CTP-3	5/16" DIAMETER PIN W/KNURLED HEAD
ATI520CTP4	AT520CTP-4	3/8" DIAMETER PIN W/KNURLED HEAD
ATI520CTS-2	AT520CTS-2	BALL END TERMINAL ADAPTER 1/16"
ATI520CTS-3	AT520CTS-3	BALL END TERMINAL ADAPTER 3/32"
ATI520CTS-4	AT520CTS-4	BALL END TERMINAL ADAPTER 1/8"
ATI520CTS-5	AT520CTS-5	BALL END TERMINAL ADAPTER 5/32"
ATI520CTS-6	AT520CTS-6	BALL END TERMINAL ADAPTER 3/16"
ATI520CTT2RH	AT520CTT-2	RH (#6-40) ADAPTER 1/16"
ATI520CTT20L	AT520CTT-20	LH (#6-40) ADAPTER 1/16"
ATI520CTT3RH	AT520CTT-3	RH (#10-32) ADAPTER 3/32"
ATI520CTT30L	AT520CTT-30	LH (#10-32) ADAPTER 3/32"
ATI520CTT4RH	AT520CTT-4	RH (1/4-28) ADAPTER 1/8" & 5/32"
ATI520CTT40L	AT520CTT-40	LH (1/4-28) ADAPTER 1/8" & 5/32"
ATI520CTT6RH	AT520CTT-6	RH (5/16-24) ADAPTER 3/16"
ATI520CTT60L	AT520CTT-60	LH (5/16-24) ADAPTER 3/16"
ATI520CTT7RH	AT520CTT-7	RH (3/8-24) ADAPTER 7/32" & 1/4"
ATI520CTT70L	AT520CTT-70	LH (3/8-24) ADAPTER 7/32" & 1/4"

CALIBRATION KIT

ATI520CGC

A Force Gage Kit with adaptors used to certify the cable tension indicator on the ATI520CT. This instrument will eliminate the necessity of outside calibration service.



ATI520CGC



ATI520H

The ATI520H is furnished with an Enerpac pump which operates on air supply of 100-120 psi. Swaging is accomplished by applying a designated number of pressure increments while rotating the cable-terminal assembly. The swaging action is virtually maintenance-free, consisting of merely two moving parts.

An adapter is provided which allows the ATI520H to accept standard ATI520-series swaging dies, used with both the ATI520J and ATI520D pneumatic swagers. With that additional capability, this portable hydraulic unit can satisfy all aircraft-type cable swaging requirements.



HYDRAULIC PORTABLE SWAGER KIT

ATI520HK

The ATI520HK consists of the ATI520H Swager, and thirteen pair of over-sized dies shown below. The kit includes a sleeve, which when installed, provides the operator the capability to swage with standard swaging dies as shown on the previous page.

Part Number	Cable Diameter	Terminal Ref.
ATI520CDB-7	7/32"	MS20663-7
ATI520CDB-8	1/4"	MS20663-8
ATI520CDB-9	9/32"	MS20663-9
ATI520CDB-10	5/16"	MS20663-10
ATI520CSB-7	7/32"	MS20664-7
ATI520CSB-8	1/4"	MS20664-8
ATI520CSB-9	9/32"	MS20664-9
ATI520CSB-10	5/16"	MS20664-10
ATI520CB-10	5/16"	RA2487
ATI520CB-12	3/8"	RA2487
ATI520CS-9	9/32"	MS21259
ATI520CS-10	5/16"	MS20667, MS20668
ATI520CS-12	3/8"	MS21260

HYDRAULIC PULL TESTER KIT

ATI520HTK

The ATI520HTK Hydraulic Pull Tester Kit provides pull-test capabilities for all swaged terminal assemblies listed on this page.



ORDERING PART #	LEGACY PART #	PAGE	ORDERING PART #	LEGACY PART #	PAGE	ORDERING PART #	LEGACY PART #	PAGE	ORDERING PART #	LEGACY PART #	PAGE
ATI207A-5R	AT207A-5-R	33	ATI336A	AT336A	37	ATI407-4	AT407-4	42	ATI413-5	AT413-5	63
ATI207A-5S	AT207A-5-S	33	ATI336B	AT336B	37	ATI408A-2	AT408A-2	61	ATI413-50X	AT413-50X	63
ATI207A-6P	AT207A-6-P	33	ATI337A	AT337A	37	ATI408A-4	AT408A-4	61	ATI413-51	AT413-51	63
ATI207A-6R	AT207A-6-R	33	ATI337B	AT337B	37	ATI408A26F3	AT408A2-6F-3	61	ATI413-51X	AT413-51X	63
ATI207A-6S	AT207A-6-S	33	ATI338A	AT338A	37	ATI408A26F4	AT408A2-6F-4	61	ATI413-52	AT413-52	63
ATI207A-8P	AT207A-8-P	33	ATI338B	AT338B	37	ATI408B-2	AT408B-2	61	ATI413-52X	AT413-52X	63
ATI207A-8R	AT207A-8-R	33	ATI339A	AT339A	37	ATI408B-4	AT408B-4	61	ATI413-53	AT413-53	63
ATI2165-2	AT2165-2	12	ATI339B	AT339B	37	ATI408C-2	AT408C-2	61	ATI413-53X	AT413-53X	63
ATI2165-3	AT2165-3	12	ATI339EC	AT339EC	41	ATI408C-4	AT408C-4	61	ATI413-54	AT413-54	63
ATI2165-4	AT2165-4	12	ATI35391132	ATSK35391T-11/32	69	ATI408CA6F0	AT408CA-6F-0	61	ATI413-54X	AT413-54X	63
ATI2165-5	AT2165-5	12	ATI35391T14	ATSK35391T-1/4	69	ATI408CA6F4	AT408CA-6F-4	61	ATI413-55	AT413-55	63
ATI2165-6	AT2165-6	12	ATI35391T38	ATSK35391T-3/8	69	ATI408CB6F0	AT408CB-6F-0	61	ATI413-55X	AT413-55X	63
ATI2200CSK	AT2200CSK	59	ATI35391T516	ATSK35391T-5/16	69	ATI408D-2	AT408D-2	61	ATI41356	AT41356	63
ATI227AH	AT227AH	34	ATI35391T716	ATSK35391T-7/16	69	ATI408E-2	AT408E-2	61	ATI413-56X	AT413-56X	63
ATI2351F1	N/A	58	ATI3581-10	N/A	70	ATI408E-4	AT408E-4	61	ATI413-57	AT413-57	63
ATI2351H4	N/A	58	ATI3581-12	N/A	70	ATI408EC6F4	AT408EC-6F-4	61	ATI413-57X	AT413-57X	63
ATI2351I1	N/A	58	ATI3581-14	N/A	70	ATI408F-2	AT408F-2	61	ATI413-58	AT413-58	63
ATI2351H4	N/A	58	ATI3581-16	N/A	70	ATI408F-4	AT408F-4	61	ATI413-58X	AT413-58X	63
ATI2351N1	N/A	58	ATI3581-18	N/A	70	ATI408FC6F-4	AT408FC-6F-4	61	ATI413-59	AT413-59	63
ATI2351N4	N/A	58	ATI3581-20	N/A	70	ATI408G-2	AT408G-2	61	ATI4135X	AT413-5X	63
ATI2351S1	N/A	58	ATI3581-4PC	N/A	70	ATI408G-4	AT408G-4	61	ATI4136	AT413-6	63
ATI2351S4	N/A	58	ATI3581-5	N/A	70	ATI408GC6F0	AT408GC-6F-0	61	ATI413-6X	AT413-6X	63
ATI247BC	AT247BC	34	ATI3581-6	N/A	70	ATI408GC6F3	AT408GC-6F-3	61	ATI413-7	AT413-7	63
ATI249PD	AT249PD	34	ATI3581-8	N/A	70	ATI408GC6F4	AT408GC-6F-4	61	ATI4137X	AT413-7X	63
ATI251DA-3	AT251DA-3	35	ATI3581K	N/A	70	ATI408H-2	AT408H-2	61	ATI413-8	AT413-8	63
ATI251DA-4	AT251DA-4	35	ATI3585-5B	N/A	70	ATI408H-4	AT408H-4	61	ATI413-8X	AT413-8X	63
ATI251DA-5	AT251DA-5	35	ATI3585-6A	N/A	70	ATI413-1	AT413-1	63	ATI413-9	AT413-9	63
ATI251DA6	AT251DA-6	35	ATI3585-6B	N/A	70	ATI41310	AT413-10	63	ATI4139X	AT413-9X	63
ATI251DA8	AT251DA-8	35	ATI3585-8A	N/A	70	ATI41310X	AT413-10X	63	ATI415-0	AT415-0	64
ATI251DB-10	AT251DB-10	35	ATI3585-8B	N/A	70	ATI413-11	AT413-11	63	ATI415-1	AT415-1	64
ATI251DB-12	AT251DB-12	35	ATI3585-8C	N/A	70	ATI413-11X	AT413-11X	63	ATI415-10	AT415-10	64
ATI251DB-8	AT251DB-8	35	ATI3588K	N/A	70	ATI413-12	AT413-12	63	ATI415-2	AT415-2	64
ATI251DC-3	AT251DC-3	35	ATI3594	AT3594	68	ATI413-12X	AT413-12X	63	ATI415-3	AT415-3	64
ATI251DC-4	AT251DC-4	35	ATI3594-2X	ATSK3594-2X	68	ATI413-13	AT413-13	63	ATI415-5	AT415-5	64
ATI251DC-5	AT251DC-5	35	ATI3594-4X	ATSK3594-4X	68	ATI413-13X	AT413-13X	63	ATI416-12	AT416-12	62
ATI251DD-10	AT251DD-10	35	ATI3594K	ATSK3594K	68	ATI413-14	AT413-14	63	ATI416-2	AT416-2	62
ATI251DD-12	AT251DD-12	35	ATI3595	ATSK3595	68	ATI413-14X	AT413-14X	63	ATI416-21	AT416-21	62
ATI251DD-2	AT251DD-2	35	ATI3596-19	ATSK3596-19	68	ATI413-15	AT413-15	63	ATI416-31	AT416-31	62
ATI251DD-5	AT251DD-5	35	ATI3596-22	ATSK3596-22	68	ATI413-15X	AT413-15X	63	ATI416-32	AT416-32	62
ATI251DD-7	AT251DD-7	35	ATI3596-25	ATSK3596-25	68	ATI413-16	AT413-16	63	ATI416-56	AT416-56	62
ATI251DD-8	AT251DD-8	35	ATI3596-26	ATSK3596-26	68	ATI413-16X	AT413-16X	63	ATI416-57	AT416-57	62
ATI252DA-10	AT252DA-10	35	ATI3596-28	ATSK3596-28	68	ATI413-17	AT413-17	63	ATI416-59	AT416-59	62
ATI252DA-3	AT252DA-3	35	ATI3596-31	ATSK3596-31	68	ATI413-17X	AT413-17X	63	ATI416-61	AT416-61	62
ATI252DA-4	AT252DA-4	35	ATI3596-34	ATSK3596-34	68	ATI413-18	AT413-18	63	ATI416-63	AT416-63	62
ATI252DA-5	AT252DA-5	35	ATI3596-38	ATSK3596-38	68	ATI413-18X	AT413-18X	63	ATI416-65	AT416-65	62
ATI252DA-6	AT252DA-6	35	ATI3597-38	AT3597-38	68	ATI41319	AT413-19	63	ATI416-69	AT416-69	62
ATI252DA-8	AT252DA-8	35	ATI3597-44	AT3597-44	68	ATI41319X	AT413-19X	63	ATI418A-4	AT418A-4	62
ATI252DB-10	AT252DB-10	35	ATI3597-50	AT3597-50	68	ATI413-1X	AT413-1X	63	ATI418B-4	AT418B-4	62
ATI252DB-12	AT252DB-12	35	ATI3597-3X	ATSK3597-3X	68	ATI413-2	AT413-2	63	ATI418C-4	AT418C-4	62
ATI252DB-8	AT252DB-8	35	ATI3600K	ATSK3594/95K	68	ATI413-20	AT413-20	63	ATI418D-4	AT418D-4	62
ATI252DC-3	AT252DC-3	35	ATI402A-4	AT402A-4	60	ATI413-20X	AT413-20X	63	ATI418E4	AT418E-4	62
ATI252DC-4	AT252DC-4	35	ATI402B-4	AT402B-4	60	ATI413-21	AT413-21	63	ATI418F4	AT418F-4	62
ATI252DC-5	AT252DC-5	35	ATI402C-4	AT402C-4	60	ATI413-21X	AT413-21X	63	ATI418G4	AT418G-4	62
ATI252DD-10	AT252DD-10	35	ATI402D-4	AT402D-4	60	ATI413-22	AT413-22	63	ATI420A4332	AT420A-4 3/32	52
ATI252DD-12	AT252DD-12	35	ATI402E-4	AT402E-4	60	ATI413-22X	AT413-22X	63	ATI420A440	AT420A-4 #40	52
ATI252DD-2	AT252DD-2	35	ATI402F-4	AT402F-4	60	ATI41323	AT413-23	63	ATI420B43/16	AT420B-4 3/16	52
ATI252DD-5	AT252DD-5	35	ATI402G-4	AT402G-4	60	ATI413-23X	AT413-23X	63	ATI420B43/32	AT420B-4 3/32	52
ATI252DD-7	AT252DD-7	35	ATI402H-4	AT402H-4	60	ATI41324	AT413-24	63	ATI420B45/32	AT420B-4 5/32	52
ATI252DD-8	AT252DD-8	35	ATI402I-4	AT402I-4	60	ATI413-24X	AT413-24X	63	ATI420B49/64	AT420B-4 9/64	52
ATI252DD-9	AT252DD-9	35	ATI402J-4	AT402J-4	60	ATI413-25	AT413-25	63	ATI420C4 096	AT420C-4-096	52
ATI254DA-10	AT254DA-10	35	ATI402K-4	AT402K-4	60	ATI413-25X	AT413-25X	63	ATI420C41/4	AT420C-4 1/4	52
ATI254DA-3	AT254DA-3	35	ATI402L-4	AT402L-4	60	ATI413-26	AT413-26	63	ATI420C4 1/10	AT420C-4 #10	52
ATI254DA-4	AT254DA-4	35	ATI402M-4	AT402M-4	60	ATI413-26X	AT413-26X	63	ATI420C4 11/64	AT420C-4 11/64	52
ATI254DA-5	AT254DA-5	35	ATI402N-4	AT402N-4	60	ATI413-27	AT413-27	63	ATI420C4 13	AT420C-4 #13	52
ATI254DA-6	AT254DA-6	35	ATI402O-4	AT402O-4	60	ATI413-27X	AT413-27X	63	ATI420C4 1/8	AT420C-4 1/8	52
ATI254DA-8	AT254DA-8	35	ATI402P-4	AT402P-4	60	ATI413-28	AT413-28	63	ATI420C4 20	AT420C-4 #20	52
ATI254DB-10	AT254DB-10	35	ATI402Q-4	AT402Q-4	60	ATI413-28X	AT413-28X	63	ATI420C4 21	AT420C-4 #21	52
ATI254DB-12	AT254DB-12	35	ATI402R-4	AT402R-4	60	ATI413-29	AT413-29	63	ATI420C4 30	AT420C-4 #30	52
ATI254DB-3	AT254DB-3	35	ATI402S-4	AT402S-4	60	ATI413-29X	AT413-29X	63	ATI420C4 316	AT420C-4 3/16	52
ATI254DB-8	AT254DB-8	35	ATI402T-4	AT402T-4	60	ATI4132X	AT413-2X	63	ATI420C4 332	AT420C-4 3/32	52
ATI254DC-3	AT254DC-3	35	ATI402U-4	AT402U-4	60	ATI413-3	AT413-3	63	ATI420C4 40	AT420C-4 #40	52
ATI254DC-4	AT254DC-4	35	ATI402V-4	AT402V-4	60	ATI41330	AT413-30	63	ATI420C4 45/16	AT420C-4 5/16	52
ATI254DC-5	AT254DC-5	35	ATI402W-4	AT402W-4	60	ATI413-30X	AT413-30X	63	ATI420C4 5/32	AT420C-4 5/32	52
ATI254DD-10	AT254DD-10	35	ATI402X-4	AT402X-4	60	ATI413-31	AT413-31	63	ATI420C4 9/64	AT420C-4 9/64	52
ATI254DD-12	AT254DD-12	35	ATI403A	AT403A	60	ATI413-31X	AT413-31X	63	ATI420D4 1/4	AT420D-4 1/4	52
ATI254DD-2	AT254DD-2	35	ATI403B	AT403B	60	ATI413-32	AT413-32	63	ATI420D4 1/8	AT420D-4 1/8	52
ATI254DD-5	AT254DD-5	35	ATI403C	AT403C	60	ATI413-32X	AT413-32X	63	ATI420D4 10	AT420D-4 #10	52
ATI254DD-7	AT254DD-7	35	ATI403D	AT403D	60	ATI413-33	AT413-33	63	ATI420D4 11	AT420D-4 #11	52
ATI254DD-8	AT254DD-8	35	ATI403E	AT403E	60	ATI413-33X	AT413-33X	63	ATI420D4 1164	AT420D-4 11/64	52
ATI259G	AT259G	34	ATI403F	AT403F	60	ATI413-34	AT413-34	63	ATI420D4 13	AT420D-4 #13	52
ATI259GP	AT259GP	34	ATI403G	AT403G	60	ATI413-34X	AT413-34X	63	ATI420D4 16	AT420D-4 #16	52
ATI259H	AT259H	34	ATI403H	AT403H	60	ATI413-35	AT413-35	63	ATI420D4 20	AT420D-4 #20	52
ATI259J	AT259J	34	ATI403I	AT403I	60	ATI413-35X	AT413-35X	63	ATI420D4 21	AT420D-4 #21	52
ATI2612	2-612	15	ATI403J	AT403J	60	ATI413-36	AT413-36	63	ATI420D4 27	AT420D-4 #27	52
ATI268P-1/4	268P-1/4	75	ATI403K	AT403K	60	ATI413-36X	AT413-36X	63	ATI420D4 3/16	AT420D-4 3/16	52
ATI268P10	AT268P-10	75	ATI403L	AT403L	60	ATI413-37	AT413-37	63	ATI420D4 3/32	AT420D-4 3/32	52
ATI268P4	268P4	75	ATI403M	AT403M	60	ATI413-37X	AT413-37X	63	ATI420D4 40	AT420D-4 #40	52
ATI268P6	268P6	75	ATI403N	AT403N	60	ATI413-38	AT413-38	63	ATI420D4 43	AT420D-4 #43	52
ATI268P8	268P8	75	ATI403O	AT403O	60	ATI413-38X	AT413-38X	63	ATI420D4 45/16	AT420D-4 5/16	52
ATI269C3	269C3	15	ATI403P	AT403P	60	ATI413-39	AT413-39	63	ATI420D4 5/32	AT420D-4 5/32	52
ATI2979U	AT2979U	69.70	ATI403Q	AT403Q	60	ATI413-39X	AT413-39X	63	ATI420D4 7/32	AT420D-4 7/32	52
ATI300B	AT300B	37	ATI403R	AT403R	60	ATI413-3X	AT413-3X	63	ATI420D4 9/64	AT420D-4 9/64	52
ATI301B	AT301B	37	ATI403S	AT403S	60						

ATI TOOLS

MODEL NUMBER INDEX



ORDERING PART #	LEGACY PART #	PAGE	ORDERING PART #	LEGACY PART #	PAGE	ORDERING PART #	LEGACY PART #	PAGE	ORDERING PART #	LEGACY PART #	PAGE
ATI420G4316	AT420G-4-3/16	52	ATI445E420	AT445E-4 #20	52	ATI47434	AT474-34	64	ATI489C-28	AT489C-28	65
ATI420G438	AT420G-4 3/8	52	ATI445E421	AT445E-4 #21	52	ATI47434X	AT474-34X	64	ATI489C-29	AT489C-29	65
ATI420G451/6	AT420G-4 5/16	52	ATI445E427	AT445E-4 #27	52	ATI47435	AT474-35	64	ATI489C-30	AT489C-30	65
ATI420G4N8	AT420G-4 #8	52	ATI445E43/16	AT445E-4 3/16	52	ATI47435X	AT474-35X	64	ATI489C-31	AT489C-31	65
ATI429A-1	AT429A-1	66	ATI445E43/32	AT445E-4 3/32	52	ATI47436	AT47436	64	ATI489C-32	AT489C-32	65
ATI429A-2	AT429A-2	66	ATI445E43/8	AT445E-4 3/8	52	ATI47436X	AT47436X	64	ATI489C-33	AT489C-33	65
ATI429A-3	AT429A-3	66	ATI445E430	AT445E-4 #30	52	ATI47437	AT47437	64	ATI489C-34	AT489C-34	65
ATI429A-4	AT429A-4	66	ATI445E440	AT445E-4 #40	52	ATI47437X	AT474-37X	64	ATI489C-5	AT489C-5	65
ATI429A-5	AT429A-5	66	ATI445E45/16	AT445E-4 5/16	52	ATI47438	AT474-38	64	ATI489C-6	AT489C-6	65
ATI429A-6	AT429A-6	66	ATI445E47/32	AT445E-4 7/32	52	ATI47438X	AT474-38X	64	ATI489C-7	AT489C-7	65
ATI429A-7	AT429A-7	66	ATI445E48	AT445E-4 #8	52	ATI47439	AT474-39	64	ATI489C-8	AT489C-8	65
ATI429B-0	AT429B-0	66	ATI445E4964	AT445E-4 9/64	52	ATI47439X	AT474-39X	64	ATI489C-9	AT489C-9	65
ATI429B-1	AT429B-1	66	ATI445E-4PC	AT445E-4PC	53	ATI4743X	AT4743X	64	ATI489A-1	AT489A-1	65
ATI429B2	AT429B-2	66	ATI445E-5PC	AT445E-5PC	53	ATI474-4	AT474-4	64	ATI489A-10	AT489A-10	65
ATI429B-3	AT429B-3	66	ATI445E-9PC	AT445E-9PC	53	ATI474-40	AT474-40	64	ATI489A-11	AT489A-11	65
ATI429B-4	AT429B-4	66	ATI445G1/2	AT445G-4-1/2	52	ATI474-40X	AT474-40X	64	ATI489A-2	AT489A-2	65
ATI429B-5	AT429B-5	66	ATI445G4 1/4	AT445G-4 1/4	52	ATI474-41	AT474-41	64	ATI489A-3	AT489A-3	65
ATI429B-6	AT429B-6	66	ATI445G43/8	AT445G-4 3/8	52	ATI474-41X	AT474-41X	64	ATI489A-4	AT489A-4	65
ATI429B-7	AT429B-7	66	ATI445G430	AT445G-4 #30	52	ATI474-42	AT474-42	64	ATI489A-5	AT489A-5	65
ATI429SXC	AT429SXC	66	ATI445G441N	AT445G-4 #41	52	ATI474-42X	AT474-42X	64	ATI489A-6	AT489A-6	65
ATI432A	AT432A	59	ATI445G45/16	AT445G-4 5/16	52	ATI474-43	AT474-43	64	ATI489A-7	AT489A-7	65
ATI432B	AT432B	59	ATI448S1	N/A	58	ATI47443X	AT47443X	64	ATI489A-8	AT489A-8	65
ATI435-1/2	AT435-1/2	56	ATI448S3	N/A	58	ATI47444	AT47444	64	ATI489A-9	AT489A-9	65
ATI435-1/4	AT435-1/4	56	ATI449S2	N/A	58	ATI474-44X	AT474-44X	64	ATI489B-10	AT489B-10	65
ATI435-3/16	AT435-3/16	56	ATI449S3	N/A	58	ATI47445	AT47445	64	ATI489B-11	AT489B-11	65
ATI435-3/8	AT435-3/8	56	ATI455A-4	AT455A-4	54	ATI47445X	AT47445X	64	ATI489B-12	AT489B-12	65
ATI435-5/16	AT435-5/16	56	ATI455B-4	AT455B-4	54	ATI47446	AT47446	64	ATI489B-13	AT489B-13	65
ATI437C	AT437C	42	ATI455C-4	AT455C-4	54	ATI47446X	AT474-46X	64	ATI489B-14	AT489B-14	65
ATI437C-1	AT437C-1	42	ATI455CTC-4	AT455CTC-4	54	ATI474-47	AT474-47	64	ATI489B-15	AT489B-15	65
ATI437C-2	AT437C-2	42	ATI455CTE-4	AT455CTE-4	54	ATI474-47X	AT474-47X	64	ATI489B-16	AT489B-16	65
ATI437C-3	AT437C-3	42	ATI455CTG-4	AT455CTG-4	54	ATI474-48	AT474-48	64	ATI489B-17	AT489B-17	65
ATI438BRC10	AT438BRC-10	56	ATI455D-4	AT455D-4	54	ATI474-48X	AT474-48X	64	ATI489B-2	AT489B-2	65
ATI438BRC3	AT438BRC-3	56	ATI455E-4	AT455E-4	54	ATI47449	AT47449	64	ATI489B-3	AT489B-3	65
ATI438BRC-4	AT438BRC-4	56	ATI455F-4	AT455F-4	54	ATI474-49X	AT474-49X	64	ATI489B-4	AT489B-4	65
ATI438BRC-5	AT438BRC-5	56	ATI455G-4	AT455G-4	54	ATI474-4X	AT474-4X	64	ATI489B-5	AT489B-5	65
ATI438BRC-6	AT438BRC-6	56	ATI455H-4	AT455H-4	54	ATI474-5	AT474-5	64	ATI489B-6	AT489B-6	65
ATI438BRC-7	AT438BRC-7	56	ATI455J-4	AT455J-4	54	ATI474-50	AT474-50	64	ATI489B-7	AT489B-7	65
ATI438BRC-8	AT438BRC-8	56	ATI455PDE-4	AT455PDE-4	54	ATI474-50X	AT474-50X	64	ATI489B-8	AT489B-8	65
ATI438BRC9	AT438BRC-9	56	ATI455PDG4	AT455PDG-4	54	ATI474-51	AT474-51	64	ATI489B-9	AT489B-9	65
ATI442S1	N/A	58	ATI455PDH-4	AT455PDH-4	54	ATI474-51X	AT474-51X	64	ATI489C-10	AT489C-10	65
ATI443 SERIES	N/A	57	ATI455SKE-4	AT455SKE-4	54	ATI474-52	AT474-52	64	ATI489C-11	AT489C-11	65
ATI444 SERIES	N/A	57	ATI455SKG-4	AT455SKG-4	54	ATI474-52X	AT474-52X	64	ATI489C-12	AT489C-12	65
ATI445A-4-30	AT445A-4 #30	52	ATI462	AT462	59	ATI474-53	AT474-53	64	ATI489C-13	AT489C-13	65
ATI445A430S2	AT445A-4 #30 SP-10-32 THRD	52	ATI462H3-1.3	AT462H3-1.3	59	ATI474-53X	AT474-53X	64	ATI489C-14	AT489C-14	65
ATI445A432S	AT445A-4 3/32 SP-10-32 THRD	52	ATI462H3-1.5	AT462H3-1.5	59	ATI47454	AT47454	64	ATI489C-15	AT489C-15	65
ATI445A4-40N	AT445A-4 #40	52	ATI462H7-1.3	AT462H7-1.3	59	ATI474-54X	AT474-54X	64	ATI489C-16	AT489C-16	65
ATI445A440S2	AT445A-4 #40 SP-10-32 THRD	52	ATI462H7-1.5	AT462H7-1.5	59	ATI474-55	AT474-55	64	ATI489C-17	AT489C-17	65
ATI445B41620	AT445B-4-1620	52	ATI463145065	AT463-145-065	62	ATI474-55X	AT474-55X	64	ATI489C-18	AT489C-18	65
ATI445C41/8	AT445C-4 1/8	52	ATI463210096	AT463-210-096	62	ATI47456	AT47456	64	ATI489C-19	AT489C-19	65
ATI445C-4-10	AT445C-4 #10	52	ATI463256126	AT463-256-1265	62	ATI474-56X	AT474-56X	64	ATI489C-20	AT489C-20	65
ATI445C41164	AT445C-4 11/64	52	ATI463317157	AT463-317-157	62	ATI474-57	AT474-57	64	ATI489C-21	AT489C-21	65
ATI445C-4-21	AT445C-4 #21	52	ATI463385191	AT463-385-1915	62	ATI474-57X	AT474-57X	64	ATI489C-22	AT489C-22	65
ATI445C-427	AT445C-4 #27	52	ATI463507247	AT463-507-247	62	ATI474-58	AT474-58	64	ATI489C-23	AT489C-23	65
ATI445C42N	AT445C-4 #2	52	ATI463595309	AT463-595-309	62	ATI474-58X	AT474-58X	64	ATI489C-24	AT489C-24	65
ATI445C430	AT445C-4 #30	52	ATI470A-1	AT470A-1	65	ATI474-59	AT474-59	64	ATI489C-25	AT489C-25	65
ATI445C4-316	AT445C-4 3/16	52	ATI470A-2	AT470A-2	65	ATI474-5X	AT474-5X	64	ATI489C-5	AT489C-5	65
ATI445C-4-40	AT445C-4 #40	52	ATI470B1	AT470B-1	56	ATI474-6	AT474-6	64	ATI489C-6	AT489C-6	65
ATI445C4216	AT445C4-216	53	ATI470B1F	AT470B-1F	56	ATI4746X	AT474-6X	64	ATI489C-7	AT489C-7	65
ATI445C421	AT445C4-21	53	ATI470B-2	AT470B-2	56	ATI474-7	AT474-7	64	ATI489C-8	AT489C-8	65
ATI445C419N	AT445C4-19	53	ATI470B-2F	AT470B-2F	56	ATI474-7X	AT474-7X	64	ATI489C-9	AT489C-9	65
ATI445C41364	AT445C4-1364	53	ATI470M6-1	AT470M6-1	56	ATI474-8	AT474-8	64	ATI493C-0	AT493C-0	62
ATI445C4111N	AT445C4-111	53	ATI470M6-4	AT470M6-4	56	ATI474-8X	AT474-8X	64	ATI493C-00	AT493C-00	62
ATI445C419N	AT445C4-19	53	ATI474-1	AT474-1	64	ATI474-9	AT474-9	64	ATI493C-1	AT493C-1	62
ATI445C4158	AT445C4-1580	53	ATI474-10	AT474-10	64	ATI4749X	AT474-9X	64	ATI493C-2	AT493C-2	62
ATI445C416N	AT445C4-16	53	ATI474-10X	AT474-10X	64	ATI484-12	AT484-12	56	ATI493C-3	AT493C-3	62
ATI445C4183	AT445C4-1830	53	ATI474-11	AT474-11	64	ATI484-2	AT484-2	56	ATI493D-1	AT493D-1	62
ATI445C4186	AT445C4-186	53	ATI474-11X	AT474-11X	64	ATI484-2 38M	AT484-2 38MM	56	ATI493D-3	AT493D-3	62
ATI445C4188	AT445C4-1880	53	ATI474-12	AT474-12	64	ATI484-2 50M	AT484-2 50MM	56	ATI500-51	AT500-51	40
ATI445C4192	AT445C4-192	53	ATI474-12X	AT474-12X	64	ATI484-21	AT484-21	56	ATI500-52	AT500-52	40
ATI445C4199	AT445C4-199	53	ATI474-13	AT474-13	64	ATI484-3.17M	AT484-3.17MM	56	ATI500-53	AT500-53	40
ATI445C4199N	AT445C4-19	53	ATI474-13X	AT474-13X	64	ATI484-3.50M	AT484-3.50MM	56	ATI500-54	AT500-54	40
ATI445C420N	AT445C4-20	53	ATI474-14	AT474-14	64	ATI484-3.96M	AT484-3.96MM	56	ATI50055	AT500-55	40
ATI445C4215	AT445C4-1215	53	ATI474-14X	AT474-14X	64	ATI484-31	AT484-31	56	ATI500-56	AT500-56	40
ATI445C4243	AT445C4-2430	53	ATI474-15	AT474-15	64	ATI484-32	AT484-32	56	ATI500-57	AT500-57	40
ATI445C4246	AT445C4-246	53	ATI474-15X	AT474-15X	64	ATI484-4.00M	AT484-4.00MM	56	ATI500-58	AT500-58	40
ATI445C4247	AT445C4-247	53	ATI474-16	AT474-16	64	ATI484-4.76M	AT484-4.76MM	56	ATI500C-51	AT500C-51	40
ATI445C4248	AT445C4-2480	53	ATI474-16X	AT474-16X	64	ATI484-4.80M	AT484-4.80MM	56	ATI500C-52	AT500C-52	40
ATI445C4262	AT445C4-262	53	ATI474-17	AT474-17	64	ATI484-5.00M	AT484-5.00MM	56	ATI500C-53	AT500C-53	40
ATI445C4278	AT445C4-278	53	ATI474-17X	AT474-17X	64	ATI484-5.60M	AT5484-5.60MM	56	ATI500C-54	AT500C-54	40
ATI445C42N	AT445C4-2	53	ATI474-18	AT474-18	64	ATI484-56	AT484-56	56	ATI500C-55	AT500C-55	40
ATI445C4309	AT445C4-309	53	ATI474-18X	AT474-18X	64	ATI484-57	AT484-57	56	ATI500C-56	AT500C-56	40
ATI445C4310	AT445C4-3100	53	ATI474-19	AT474-19	64	ATI484-59	AT484-59	56	ATI500C-57	AT500C-57	40
ATI445C4316	AT445C4-316	53	ATI474-19X	AT474-19X	64	ATI484-6.00M	AT484-6.00MM	56	ATI500C-58	AT500C-58	40
ATI445C4324	AT445C4-324	53	ATI474-1X	AT474-1X	64	ATI484-61	AT484-61	56	ATI500CQA	N/A	59
ATI445C4325	AT445C4-325	53	ATI474-2	AT474-2	64	ATI484-63	AT484-63	56	ATI501A	AT501A	18
ATI445C4332	AT445C4-332	53	ATI474-20	AT474-20	64	ATI484-65	AT484-65	56	ATI501QCA	N/A	59
ATI445C4340	AT445C4-340	53	ATI47420X	AT474-20X	64	ATI485-12	AT485-12	56	ATI501R	AT501R	16
ATI445C4342	AT445C4-342	53	ATI474-21	AT474-21	64	ATI485-21	AT485-21	56	ATI501S	AT501S	16
ATI445C4371	AT445C4-371	53	ATI47421X	AT474-21X	64	ATI485-31	AT485-31	56	ATI502AHD	AT502AHD	18
ATI445C438	AT445C4-38										

ORDERING PART #	LEGACY PART #	PAGE	ORDERING PART #	LEGACY PART #	PAGE	ORDERING PART #	LEGACY PART #	PAGE	ORDERING PART #	LEGACY PART #	PAGE
ATI503C-20	ATS503C-20	41	ATI518KN	ATS18KN	45	ATI520CDB-2	ATS20CDB-2	81	ATI540-7	ATS40-7	76
ATI503C-21	ATS503C-21	41	ATI518KP	ATS18KP	45	ATI520CDB-3	ATS20CDB-3	81	ATI540BL-7	ATS40BL-7	75
ATI503C-3/16	ATS503C-3/16	41	ATI518KT	ATS18KT	45	ATI520CDB-4	ATS20CDB-4	81	ATI540BS-5	ATS40BS-5	75
ATI503C-3/32	ATS503C-3/32	41	ATI518KU	ATS18KU	45	ATI520CDB-5	ATS20CDB-5	81	ATI540S	ATS40S	75
ATI503C-30	ATS503C-30	41	ATI518KV	ATS18KV	45	ATI520CDB-6	ATS20CDB-6	81	ATI540SE-5	ATS40SE-5	75
ATI503C-40	ATS503C-40	41	ATI518L	ATS18L	44	ATI520CDB-7	ATS20CDB-7	83	ATI542	ATS42	73
ATI503C-5/32	ATS503C-5/32	41	ATI518LF	ATS18LF	44	ATI520CDB-8	ATS20CDB-8	83	ATI542S	ATS42S	73
ATI503C-7/32	ATS503C-7/32	41	ATI518M	ATS18M	44	ATI520CDB-9	ATS20CDB-9	83	ATI543	ATS43	73
ATI503C-F	ATS503C-F	41	ATI518MB	ATS18MB	46	ATI520CGC	ATS20CGC	82	ATI544	ATS44	73
ATI504C-1/4	ATS504C-1/4	41	ATI518MC	ATS18MC	46	ATI520CP-2	ATS20CP-2	81	ATI550SG	ATS50SG	73
ATI507-1	ATS507-1	43	ATI518MD	ATS18MD	46	ATI520CP-3	ATS20CP-3	81	ATI551HNX	ATS51HNX	74
ATI507-10	ATS507-10	43	ATI518ME	ATS18ME	46	ATI520CP-4	ATS20CP-4	81	ATI551HNXL	ATS51HNXL	74
ATI507-11	ATS507-11	43	ATI518MF	ATS18MF	46	ATI520CP-5	ATS20CP-5	81	ATI551M	ATS51M	73
ATI507-12	ATS507-12	43	ATI518MK	ATS18MK	46	ATI520CP-6	ATS20CP-6	81	ATI551MH	ATS51MH	73
ATI507-13	ATS507-13	43	ATI518ML	ATS18ML	46	ATI520CP-7	ATS20CP-7	81	ATI551SG	ATS51SG	73
ATI507-14	ATS507-14	43	ATI518MN	ATS18MN	46	ATI520CP-8	ATS20CP-8	81	ATI551WNX	ATS51WNX	73
ATI507-2	ATS507-2	43	ATI518MP	ATS18MP	46	ATI520CS-10	ATS20CS-10	83	ATI551WNXL	ATS51WNXL	73
ATI507-3	ATS507-3	43	ATI518MR	ATS18MR	46	ATI520CS-12	ATS20CS-12	83	ATI552HNX	ATS52HNX	74
ATI507-4	ATS507-4	43	ATI518MT	ATS18MT	46	ATI520CS-2	ATS20CS-2	81	ATI552HNXL	ATS52HNXL	74
ATI507-5	ATS507-5	43	ATI518MU	ATS18MU	46	ATI520CS-3	ATS20CS-3	81	ATI552M	ATS52M	73
ATI507-6	ATS507-6	43	ATI518MV	ATS18MV	46	ATI520CS-4	ATS20CS-4	81	ATI552MH	ATS52MH	73
ATI507-7	ATS507-7	43	ATI518N	ATS18N	45	ATI520CS-5	ATS20CS-5	81	ATI552SG	ATS52SG	73
ATI507-8	ATS507-8	43	ATI518NA	ATS18NA	46	ATI520CS-6	ATS20CS-6	81	ATI552WNX	ATS52WNX	73
ATI507-9	ATS507-9	43	ATI518NASA4	ATS18NAS-A-A04	46	ATI520CS-7	ATS20CS-7	81	ATI552WNXL	ATS52WNXL	73
ATI507KT	ATS507KT	43	ATI518NASAA2	ATS18NAS-A-A02	46	ATI520CS-8	ATS20CS-8	81	ATI553HNX	ATS53HNX	74
ATI508K	ATS508K	72	ATI518NASAA3	ATS18NAS-A-A03	46	ATI520CS-9	ATS20CS-9	83	ATI553HNXL	ATS53HNXL	74
ATI508K-4	ATS508K-4	72	ATI518NASAA5	ATS18NAS-A-A5	45	ATI520CSB-10	ATS20CSB-10	83	ATI553M	ATS53M	73
ATI508KG	ATS508KG	72	ATI518NASAA6	ATS18NAS-A-A6	45	ATI520CSB-2	ATS20CSB-2	81	ATI553MH	ATS53MH	73
ATI508S	ATS508S	72	ATI518NASBA2	ATS18NAS-B-A02	44	ATI520CSB-3	ATS20CSB-3	81	ATI553SG	ATS53SG	73
ATI508SG	ATS508SG	72	ATI518NASBA3	ATS18NAS-B-A03	44	ATI520CSB-4	ATS20CSB-4	81	ATI553WNX	ATS53WNX	73
ATI509A-1	N/A	72	ATI518NASBA4	ATS18NAS-B-A04	44	ATI520CSB-5	ATS20CSB-5	81	ATI553WNXL	ATS53WNXL	73
ATI509AP8	N/A	72	ATI518NASBA5	ATS18NAS-B-A05	44	ATI520CSB-6	ATS20CSB-6	81	ATI554HNX	ATS54HNX	74
ATI509PP	N/A	72	ATI518NASCA6	ATS18NAS-C-A6	46	ATI520CSB-7	ATS20CSB-7	83	ATI554HNXL	ATS54HNXL	74
ATI511	ATS511	42	ATI518NASDA5	ATS18NAS-D-A5	47	ATI520CSB-8	ATS20CSB-8	83	ATI554M	ATS54M	73
ATI512	ATS512	42	ATI518NASDA5	ATS18NAS-D-A5	47	ATI520CSB-9	ATS20CSB-9	83	ATI554MH	ATS54MH	73
ATI514	ATS514	43	ATI518NASDA6	ATS18NAS-D-A6	47	ATI520CT	ATS20CT	82	ATI554WNX	ATS54WNX	73
ATI515	ATS515	43	ATI518NASDA6	ATS18NAS-D-A6	47	ATI520CTD2	ATS20CTD-2	82	ATI554WNXL	ATS54WNXL	73
ATI518A	ATS518A	45	ATI518NB	ATS18NB	46	ATI520CTD3	ATS20CTD-3	82	ATI556HNX	ATS56HNX	74
ATI518AA	ATS518AA	46	ATI518NC	ATS18NC	46	ATI520CTD4	ATS20CTD-4	82	ATI556HNXL	ATS56HNXL	74
ATI518AB	ATS518AB	46	ATI518ND	ATS18ND	46	ATI520CTD-5	ATS20CTD-5	82	ATI556M	ATS56M	73
ATI518AC	ATS518AC	46	ATI518NE	ATS18NE	46	ATI520CTD6	ATS20CTD-6	82	ATI556MH	ATS56MH	73
ATI518AD	ATS518AD	46	ATI518NF	ATS18NF	46	ATI520CTD-7	ATS20CTD-7	82	ATI556WNX	ATS56WNX	73
ATI518AE	ATS518AE	46	ATI518NG	ATS18NG	46	ATI520CTD-8	ATS20CTD-8	82	ATI556WNXL	ATS56WNXL	73
ATI518AF	ATS518AF	46	ATI518NH	ATS18NH	46	ATI520CTF-5	ATS20CTF-5	82	ATI560A-3	ATS60A-3	76
ATI518B	ATS518B	45	ATI518NJ	ATS18NJ	46	ATI520CTF-6	ATS20CTF-6	82	ATI560A-4	ATS60A-4	76
ATI518BA	ATS518BA	46	ATI518NSAA06	ATS18NAS-A-A06	46	ATI520CTF-7	ATS20CTF-7	82	ATI560CF12	ATS60CF-12	76
ATI518BB	ATS518BB	46	ATI518NSCA02	ATS18NAS-C-A02	47	ATI520CTF-8	ATS20CTF-8	82	ATI560CF18	ATS60CF-18	76
ATI518BC	ATS518BC	46	ATI518NSCA03	ATS18NAS-C-A03	47	ATI520CTK	ATS20CTK	82	ATI560CF24	ATS60CF-24	76
ATI518BD	ATS518BD	46	ATI518NSCA04	ATS18NAS-C-A04	47	ATI520CTP-1	ATS20CTP-1	82	ATI560CF36	ATS60CF-36	76
ATI518BE	ATS518BE	46	ATI518NSCA06	ATS18NAS-C-A06	47	ATI520CTP-2	ATS20CTP-2	82	ATI560HD3	ATS60HD-3	76
ATI518BF	ATS518BF	45	ATI518NSDA08	ATS18NAS-D-A08	47	ATI520CTP-3	ATS20CTP-3	82	ATI560HD-3	ATS60HD-3	76
ATI518BG	ATS518BG	46	ATI518P	ATS18P	45	ATI520CTP-4	ATS20CTP-4	82	ATI560M	ATS60M	76
ATI518C	ATS518C	45	ATI518PA	ATS18PA	44	ATI520CTS-2	ATS20CTS-2	82	ATI560MF12	ATS60MF-12	76
ATI518D	ATS518D	45	ATI518PB	ATS18PB	44	ATI520CTS-3	ATS20CTS-3	82	ATI560MF18	ATS60MF-18	76
ATI518DF	ATS518DF	45	ATI518PC	ATS18PC	44	ATI520CTS-4	ATS20CTS-4	82	ATI560MF24	ATS60MF-24	76
ATI518E	ATS518E	45	ATI518PD	ATS18PD	44	ATI520CTS-5	ATS20CTS-5	82	ATI560MF36	ATS60MF-36	76
ATI518F	ATS518F	45	ATI518PE	ATS18PE	44	ATI520CTS-6	ATS20CTS-6	82	ATI560MFE12	ATS60MFE-12	76
ATI518FH	ATS518FH	44	ATI518PF	ATS18PF	44	ATI520CT20L	ATS20CT-20 LH	82	ATI560MFE18	ATS60MFE-18	76
ATI518G	ATS518G	44	ATI518R	ATS18R	46	ATI520CT2RH	ATS20CTT-2 RH	82	ATI560MFE24	ATS60MFE-24	76
ATI518GA	ATS518GA	45	ATI518RB	ATS18RB	44	ATI520CT30L	ATS20CTT-30 LH	82	ATI560MFE36	ATS60MFE-36	76
ATI518GB	ATS518GB	45	ATI518RC	ATS18RC	44	ATI520CT3RH	ATS20CTT-3 RH	82	ATI560MHDF18	ATS60MHDF-18	76
ATI518GC	ATS518GC	45	ATI518RD	ATS18RD	44	ATI520CT40L	ATS20CTT-40 LH	82	ATI560MP	N/A	76
ATI518GD	ATS518GD	45	ATI518RE	ATS18RE	44	ATI520CT4RH	ATS20CTT-4 RH	82	ATI560MR-12	ATS60MR-12	76
ATI518GE	ATS518GE	45	ATI518RF	ATS18RF	44	ATI520CT60L	ATS20CTT-60 LH	82	ATI560MR18	ATS60MR-18	76
ATI518GF	ATS518GF	45	ATI518RG	ATS18RG	44	ATI520CT6RH	ATS20CTT-6 RH	82	ATI560MR36	ATS60MR-36	76
ATI518GG	ATS518GG	45	ATI518RH	ATS18RH	44	ATI520CT70L	ATS20CTT-70 LH	82	ATI560MRE12	ATS60MRE-12	76
ATI518GH	ATS518GH	45	ATI518RJ	ATS18RJ	44	ATI520CT7RH	ATS20CTT-7 RH	82	ATI560MRE18	ATS60MRE-18	76
ATI518GJ	ATS518GJ	45	ATI518RL	ATS18RL	44	ATI520D	ATS20D	80	ATI560MRE36	ATS60MRE-36	76
ATI518GK	ATS518GK	45	ATI518RM	ATS18RM	44	ATI520DK	ATS20DK	80	ATI560R10	ATS60R-10	76
ATI518GL	ATS518GL	45	ATI518RO	ATS18RO	44	ATI520H	ATS20H	83	ATI560V	N/A	76
ATI518GM	ATS518GM	45	ATI518RP	ATS18RP	44	ATI520HK	ATS20HK	83	ATI560VF12	N/A	76
ATI518GN	ATS518GN	45	ATI518RU	ATS18RU	44	ATI520HTK	ATS20HTK	83	ATI560VF18	N/A	76
ATI518GP	ATS518GP	45	ATI518RW	ATS18RW	44	ATI520J	ATS20J	81	ATI560VF24	N/A	76
ATI518GR	ATS518GR	45	ATI518RX	ATS18RX	44	ATI520JK	ATS20JK	81	ATI570-1/4	ATS70-1/4	41
ATI518GS	ATS518GS	45	ATI518S	ATS18S	46	ATI520SG	ATS20SG	81	ATI570-10	ATS70-10	41
ATI518GT	ATS518GT	45	ATI518SA	ATS18SA	47	ATI521A	ATS21A	42	ATI570-11	ATS70-11	41
ATI518H	ATS518H	44	ATI518SB	ATS18SB	47	ATI521B	ATS21B	42	ATI570-12	ATS70-12	41
ATI518HA	ATS518HA	45	ATI518SC	ATS18SC	47	ATI521C	ATS21C	42	ATI570-13/64	ATS70-13/64	41
ATI518HB	ATS518HB	45	ATI518SD	ATS18SD	47	ATI529	ATS29	73	ATI570-16	ATS70-16	41
ATI518HC	ATS518HC	45	ATI518SE	ATS18SE	47	ATI530	ATS30	73	ATI570-20	ATS70-20	41
ATI518HD	ATS518HD	45	ATI518SF	ATS18SF	47	ATI532A/SET	ATS32A/SET	40	ATI570-21	ATS70-21	41
ATI518HE	ATS518HE	45	ATI518SJ	ATS18SJ	47	ATI532-61	ATS32-61	40	ATI570-27	ATS70-27	41
ATI518HF	ATS518HF	45	ATI518SP1016	ATS18SP1016	46	ATI532-62	ATS32-62	40	ATI570-28	ATS70-28	41
ATI518HG	ATS518HG	45	ATI518SP1171	ATS18SP1171	45	ATI532-63	ATS32-63	40	ATI570-30	ATS70-30	41
ATI518HH	ATS518HH	45	ATI518T	ATS18T	46	ATI532-64	ATS32-64	40	ATI570-40	ATS70-40	41
ATI518HJ	ATS518HJ	45	ATI518TA	ATS18TA	47	ATI532-65	ATS32-65	40	ATI570-5/16	ATS70-5/16	41
ATI518HK	ATS518HK	45	ATI518TB	ATS18TB	47	ATI532-66	ATS32-66	40	ATI570-50	ATS70-50	41
ATI518HL	ATS518HL	45	ATI518TC	ATS18TC	47	ATI532-67	ATS32-67	40	ATI570/32	ATS70/32	41
ATI518HM	ATS518HM	45	ATI518TD	ATS18TD	47	ATI532-68	ATS32-68	40	ATI58924T098	ATS8924-3/8-#40	39
ATI518HN	ATS518HN	45	ATI518TE	ATS18TE	47	ATI532A-61	ATS32A-61	40	ATI58924T125	ATS8924-3/8-1/8	39
ATI518HO	ATS518HO	45	ATI518U	ATS18U	46	ATI532A-62	ATS32A-62	40	ATI58924T128	ATS8924-3/8-#30	39
ATI518HP	ATS518HP	45	ATI518UA	ATS18UA	47	ATI532A-63	ATS32A-63	40	ATI58924T156	ATS8924-3/8-156	39
ATI518HS	ATS518HS	45	ATI518UB	ATS18UB	47	ATI532A-64	ATS32A-64	40	ATI58924T159	ATS8924-3/8-159	39
ATI518HT	ATS518HT	45	ATI518UC	ATS18UC	47	ATI532A-65	ATS32A-65	40	ATI58924T161	ATS8924-3/8-#20	39
ATI518HW	ATS518HW	45	ATI518UD	ATS18UD	47	ATI532A-66	ATS32A-66	40	ATI58924T177	ATS8924-3/8-#16	39
ATI518HX	ATS518HX	45	ATI518UE	ATS18UE	47	ATI532A-67	ATS32A-67	40	ATI58924T187	ATS8924-3/8-187	39
ATI518HY	ATS518HY	45	ATI518UF	ATS18UF	47	ATI532A-68	ATS32A-68	40	ATI58924T193	ATS8924-3/8-193	39
ATI518J	ATS518J	44	ATI518V	ATS18V	46	ATI532C-61	ATS32C-61	40	ATI58924T234	ATS8924-3/8-234	39
ATI518JA	ATS518JA	44	ATI518W	ATS18W	46	ATI532C-62	ATS32C-62	40	ATI58924T250	ATS8924-3/8-1/4	39
ATI518JB	ATS518JB	44	ATI518X	ATS18X	46	ATI532C-63	ATS32C-63	40	ATI589A-093	ATS89A-093	

ATI TOOLS

MODEL NUMBER INDEX



ORDERING PART #	LEGACY PART #	PAGE	ORDERING PART #	LEGACY PART #	PAGE	ORDERING PART #	LEGACY PART #	PAGE	ORDERING PART #	LEGACY PART #	PAGE
AT1589A2187	AT589A-2187	38,39	AT1649	AT649	24	AT1765T	AT765T	21	CBXBFB316	CBX-BF-3/16-PC	74
AT1589A2344	AT589A-2344	39	AT1652	AT652	24	AT1766T	AT766T	21	CBXBFB316PC	CBX-BF-5/32-PC	74
AT1589A250	AT589A-250	39	AT1653	AT653	24	AT1800FGB	AT800FGB	74	CBXBFB332PC	CBX-BF-3/32-PC	74
AT1589A257	AT589A-257	39	AT1656	AT656	24	AT1800FGC	AT800FGC	74	CBX-BF-5/32	CBX-BF-5/32	74
AT1589A-3T098	AT589A-3/8-#40	39	AT1657	AT657	24	AT1800G	AT800G	14	CBXBFB532PC	CBX-BF-3/16-PC	74
AT1589A-3T125	AT589A-3/8-1/8	39	AT1658	AT658	24	AT1800H	AT800H	14	CBXL-BF-1/4	CBXL-BF-1/4	74
AT1589A-3T128	AT589A-3/8-#30	39	AT1659	AT659	25	AT1800I	AT800I	14	CBXL-BF-1/8	CBXL-BF-1/8	74
AT1589A-3T156	AT589A-3/8-156	39	AT1661	AT661	25	AT1800J	AT800J	21	CBXLBF14PC	CBXL-BF-1/4-PC	74
AT1589A-3T159	AT589A-3/8-159	39	AT1662	AT662	25	AT1800K	AT800K	21	CBXLBF18PC	CBXL-BF-1/8-PC	74
AT1589A-3T161	AT589A-3/8-#20	39	AT1664	AT664	25	AT1800L	AT800L	21	CBXL-BF-3/16	CBXL-BF-3/16	74
AT1589A-3T177	AT589A-3/8-#16	39	AT1665	AT665	25	AT1800M	AT800M	21	CBXL-BF-3/32	CBXL-BF-3/32	74
AT1589A-3T187	AT589A-3/8-187	39	AT1668	AT668	25	AT1800N	AT800N	21	CBXLBF316PC	CBXL-BF-3/16-PC	74
AT1589A-3T193	AT589A-3/8-193	39	AT1669	AT669	25	AT1800O	AT800O	21	CBXLBF332PC	CBXL-BF-3/32-PC	74
AT1589A-3T234	AT589A-3/8-234	39	AT1670	AT670	16,25,30	AT1800P	AT800P	21	CBXLBF532	CBXL-BF-5/32	74
AT1589A-3T250	AT589A-3/8-1/4	39	AT1670	AT670	25	AT1800Q	AT800Q	21	CBXLBF532PC	CBXL-BF-5/32-PC	74
AT1589AA	AT589AA	38	AT1671	AT671	25	AT1800R	AT800R	21	JAT100A118	JAT100A-1-1/8 AN470	8
AT1589AB093	AT589AB-093	39	AT1672	AT672	25	AT1800S	AT800S	42	JAT100A1316	JAT100A-1-3/16 AN470	8
AT1589AB098	AT589AB-098	38,39	AT1674	AT674	25	AT1800T	AT800T	42	JAT100A1332	JAT100A-1-3/32 AN470	8
AT1589AB125	AT589AB-1/8	39	AT1676	AT676	25	AT1800U	AT800U	42	JAT100A1532	JAT100A-1-5/32 AN470	8
AT1589AB1285	AT589AB-1285	38,39	AT1678	AT678	25	AT1800V	AT800V	42	JAT100AF-1A	JAT100AF-1A	8
AT1589AB1562	AT589AB-1562	38,39	AT1679	AT679	25	AT1800W	AT800W	42	JAT101A118	JAT101A-1-1/8 AN470	8
AT1589AB159	AT589AB-159	38,39	AT1680	AT680	25	AT1800X	AT800X	42	JAT101A1316	JAT101A-1-3/16 AN470	8
AT1589AB-161	AT589AB-161	39	AT1681	AT681	16,25,30	AT1800Y	AT800Y	42	JAT101A1332	JAT101A-1-3/32 AN470	8
AT1589AB-166	AT589AB-166	39	AT1681	AT681	25	AT1800Z	AT800Z	42	JAT101A1532	JAT101A-1-5/32 AN470	8
AT1589AB-173	AT589AB-173	39	AT1682	AT682	26	AT1800A	AT800A	42	JAT119A-2B	JAT119A-2B	8
AT1589AB-177	AT589AB-177	39	AT1683	AT683	26	AT1800B	AT800B	42	RTW40-190	RTW40-190	77
AT1589AB1850	AT589AB-1850	39	AT1685	AT685	26	AT1800C	AT800C	42	RTW80-100	RTW80-100	77
AT1589AB1875	AT589AB-1875	39	AT1686	AT686	26	AT1800D	AT800D	42	RTWH104Y	RTWH104Y	77
AT1589AB1890	AT589AB-1890	39	AT1690	AT690	26	AT1800E	AT800E	42	RTWH120Y	RTWH120Y	77
AT1589AB191	AT589AB-191	39	AT1692	AT692	26	AT1800F	AT800F	42	RTWH128J	RTWH128J	77
AT1589AB1935	AT589AB-1935	39	AT1694	AT694	26	AT1800G	AT800G	42	RTWH128Y	RTWH128Y	77
AT1589AB-199	AT589AB-199	39	AT1698	AT698	26	AT1800H	AT800H	42	RTWH136Y	RTWH136Y	77
AT1589AB2187	AT589AB-2187	39	AT1699	AT699	26	AT1800I	AT800I	42	RTWH28J	RTWH28J	77
AT1589AB2344	AT589AB-2344	39	AT1700	AT700	26	AT1800J	AT800J	42	RTWH32J	RTWH32J	77
AT1589AB250	AT589AB-250	38,39	AT1701	AT701	26	AT1800K	AT800K	42	RTWH36J	RTWH36J	77
AT1589AB-257	AT589AB-257	38,39	AT1702	AT702	26	AT1800L	AT800L	42	RTWH36Y	RTWH36Y	77
AT1589BA	AT589BA	38	AT1707	AT707	26	AT1800M	AT800M	42	RTWH40J	RTWH40J	77
AT1589C.3125	AT589C-3125	39	AT1708	AT708	26	AT1800N	AT800N	75	RTWH40Y	RTWH40Y	77
AT1589C-500	AT589C-500	39	AT1711	AT711	26	AT1800O	AT800O	75	RTWH44J	RTWH44J	77
AT1589C-2812	AT589C-2812	39	AT1715	AT715	26	AT1800P	AT800P	75	RTWH48J	RTWH48J	77
AT1589C-3437	AT589C-3437	39	AT1718	AT718	26	AT1800Q	AT800Q	75	RTWH48Y	RTWH48Y	77
AT1589C-375	AT589C-375	39	AT1719	AT719	27	AT1800R	AT800R	75	RTWH52J	RTWH52J	77
AT1589C-4375	AT589C-4375	39	AT1720	AT720	27	AT1800S	AT800S	75	RTWH56J	RTWH56J	77
AT1589CA	AT589CA	38	AT1721	AT721	27	AT1800T	AT800T	75	RTWH56Y	RTWH56Y	77
AT1589CAM	AT589CAM	38	AT1722	AT722	27	AT1800U	AT800U	75	RTWH60J	RTWH60J	77
AT1589CB2812	AT589CB-2812	39	AT1723	AT723	27	AT1800V	AT800V	78	RTWH60Y	RTWH60Y	77
AT1589CB3125	AT589CB-3125	39	AT1724	AT724	27	AT1800W	AT800W	59	RTWH64J	RTWH64J	77
AT1589CB3437	AT589CB-3437	39	AT1725	AT725	27	AT1800X	AT800X	59	RTWH64Y	RTWH64Y	77
AT1589CB375	AT589CB-375	39	AT1727	AT727	27	AT1800Y	AT800Y	69	RTWH72Y	RTWH72Y	77
AT1589CB4375	AT589CB-4375	39	AT1728	AT728	27	AT1800Z	AT800Z	69	RTWH80J	RTWH80J	77
AT1589CB500	AT589CB-500	39	AT1729-1	AT729-1	27	AT1800A	AT800A	69	RTWH80Y	RTWH80Y	77
AT1589DA	AT589DA	38	AT1729-13T	AT729-13T	20	AT1800B	AT800B	69	RTWH88Y	RTWH88Y	77
AT1589EA	AT589EA	38	AT1729-2	AT729-2	27	AT1800C	AT800C	69	RTWH96J	RTWH96J	77
AT1590BBK	AT590BBK	30	AT1729-3	AT729-3	27	AT1800D	AT800D	69	RTWH96Y	RTWH96Y	77
AT1590CSK	AT590CSK	53	AT1729-3T	AT729-3T	20	AT1800E	AT800E	69	ST1111BV48E1	ST1111BV-498E-1	10
AT1590DBK	AT590DBK	38	AT1729-4	AT729-4	27	AT1800F	AT800F	69	ST1111BV48E2	ST1111BV-498E-2	10
AT1590L	AT590L	66	AT1729-5	AT729-5	27	AT1800G	AT800G	69	ST1111BV48E3	ST1111BV-498E-3	10
AT1590RGK3X	AT590RGK-3X	16	AT1729-6	AT729-6	27	AT1800H	AT800H	69	ST1111BVR1	ST1111BV-VR-1	10
AT1590RGK4X	AT590RGK-4X	16	AT1729-7	AT729-7	27	AT1800I	AT800I	78	ST1111BVR2	ST1111BV-VR-2	10
AT1590S	AT590S	60	AT1729-8	AT729-8	27	AT1800J	AT800J	75	ST1111BVR3	ST1111BV-VR-3	10
AT1590SMKSP1	AT590SMK-SP1	16	AT1729-9	AT729-9	27	AT1800K	AT800K	75	ST1112BC453	ST1112BC-C401-4-53	7
AT1590SMKSP6	AT590SMK-SP6	16	AT1730	AT730	27	AT1800L	AT800L	75	ST1112BC553	ST1112BC-C401-5-53	7
AT1590TA	AT590TA	60	AT1731	AT731	27	AT1800M	AT800M	75	ST1112BC653	ST1112BC-C401-6-53	7
AT1595B	AT595B	13	AT1732	AT732	27	AT1800N	AT800N	75	ST1112BC853	ST1112BC-C401-8-53	7
AT1595BK	AT595BK	13	AT1732T	AT732T	20	AT1800O	AT800O	75	ST1112MB07	ST1112MB-C401-7	7
AT1595C	AT595C	13	AT1735	AT735	27	AT1800P	AT800P	75	ST1112MBR611	ST1112MB-R401C-611	7
AT1595CK	AT595CK	13	AT1736	AT736	27	AT1800Q	AT800Q	75	ST1112MBR663	ST1112MB-R401-6-3	7
AT1601	AT601	22	AT1737	AT737	28	AT1800R	AT800R	75	T5200210100	T5200210100	78
AT1602	AT602	22	AT1750D-23	AT750D-23	28	AT1800S	AT800S	78	T5200210400	T5200210400	78
AT1603	AT603	22	AT1750E-1	AT750E-1	28	AT1800T	AT800T	78	T5200413000	T5200413000	78
AT1604	AT604	22	AT1750J-5	AT750J-5	28	AT1800U	AT800U	78	T5800210500	T5800210500	78
AT1605	AT605	22	AT1750J-51	AT750J-51	28	AT1800V	AT800V	42	T58002211000	T58002211000	78
AT1606	AT606	22	AT1750K-1	AT750K-1	28	AT1800W	AT800W	42	T5800310600	T5800310600	78
AT1607	AT607	22	AT1750K-2	AT750K-2	28	AT1800X	AT800X	42	T5800510000	T5800510000	78
AT1608	AT608	22	AT1750N-1	AT750N-1	28	AT1800Y	AT800Y	42	T5800810600	T5800810600	78
AT1609	AT609	22	AT1750N-26	AT750N-26	28	AT1800Z	AT800Z	42	T601001C81A	T601001C81A	78
AT1610	AT610	22	AT1750P-3	AT750P-3	28	AT1800A	AT800A	42	T601001C91A	T601001C91A	78
AT1611	AT611	22	AT1750S-1	AT750S-1	28	AT1800B	AT800B	42			
AT1612	AT612	22	AT1750S-61	AT750S-61	28	AT1800C	AT800C	42			
AT1613	AT613	22	AT1750T-1	AT750T-1	28	AT1800D	AT800D	10			
AT1613T	AT613T	22	AT1750U-1	AT750U-1	28	AT1800E	AT800E	10			
AT1614	AT614	22	AT1750V-1	AT750V-1	28	AT1800F	AT800F	10			
AT1614T	AT614T	22	AT1750Y-1	AT750Y-1	28	AT1800G	AT800G	75			
AT1616	AT616	22	AT1750Z-1	AT750Z-1	29	AT1800H	AT800H	75			
AT1618	AT618	22	AT1751B-21	AT751B-21	29	AT1800I	AT800I	75			
AT1619	AT619	23	AT1751K-1	AT751K-1	29	AT1800J	AT800J	75			
AT1620	AT620	23	AT1751L-4	AT751L-4	29	AT1800K	AT800K	75			
AT1621	AT621	23	AT1751R-H	AT751R-H	29	AT1800L	AT800L	75			
AT1622	AT622	23	AT1751U-1	AT751U-1	29	AT1800M	AT800M	75			
AT1624	AT624	23	AT1751V-1	AT751V-1	29	AT1800N	AT800N	75			
AT1625	AT625	23	AT1751Y-11	AT751Y-11	29	AT1800O	AT800O	75			
AT1626	AT626	23	AT1752A-1	AT752A-1	29	AT1800P	AT800P	75			
AT1627	AT627	23	AT1752B-1	AT752B-1	29	AT1800Q	AT800Q	75			
AT1628	AT628	23	AT1752C-1	AT752C-1	29	AT1800R	AT800R	18			
AT1629	AT629	23	AT1752F-1	AT752F-1	29	AT1800S	AT800S	18			
AT1630	AT630	23	AT1752P-1	AT752P-1	29	AT1800T	AT800T	18			
AT1632	AT632	23	AT1752T-1	AT752T-1	29	AT1800U	AT800U	18			
AT1633	AT633	23	AT1752V-1	AT752V-1	29	AT1800V	AT800V	18			
AT1634	AT634	23	AT1752Z-1	AT752Z-1	2						

A LEGACY BRAND SINCE 1938!

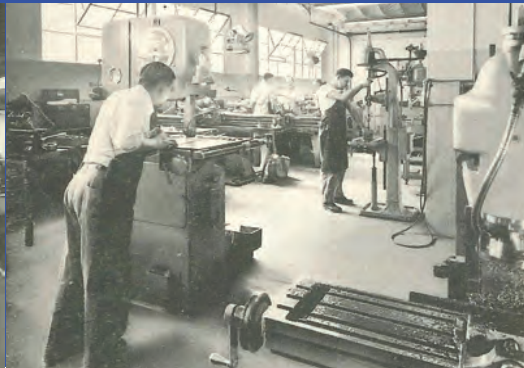

ATI® TOOLS

A Snap-on Specialty Tools Brand

TOOLS FOR
AIRCRAFT PRODUCTION
AND
MAINTENANCE



SALES HEADQUARTERS

ATI Tools
2801 80th Street
Kenosha, WI 53143

USA CUSTOMER SERVICE

TOLL FREE: USA 877-740-1900
USA: 800-284-4460
FAX: 877-740-1880
Email: atiorders@snapon.com
www.atitools.com

DISTRIBUTION CENTER

ATI Tools
6969 Jamesson Road
Midland, GA 31820

PRODUCT CATALOG